

INSTRUCTION MANUAL

Before using the TV, please read this manual thoroughly, and retain it for future reference.

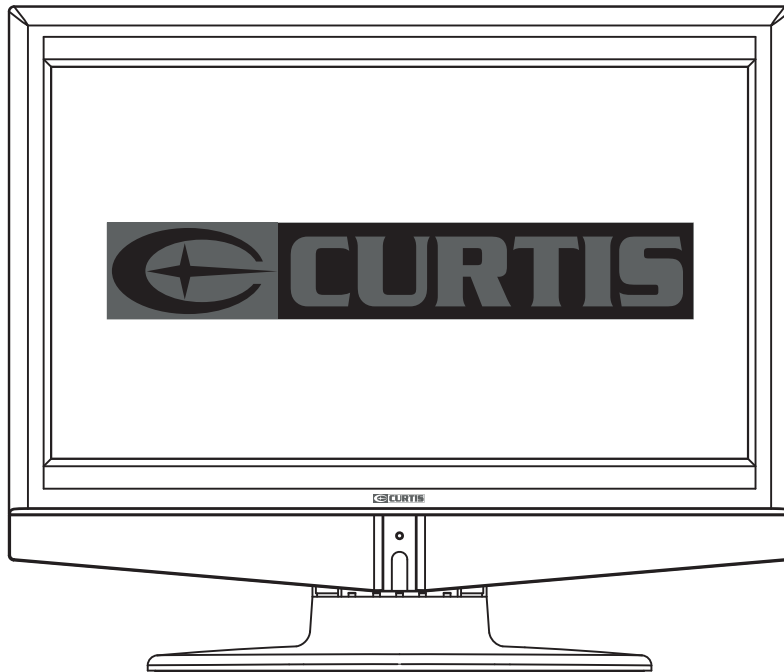

Model:LCDVD193A

CONTENTS

1	SAFETY PRECAUTION		1
2	IMPORTANT SAFETY INSTRUCTION		2
3	MAINTENANCE		2
4	ACCESSORIES		3
5	GETTING STARTED		3
6	CONTROL REFERENCE GUIDE	Remote Control	4
		Front Frame	6
		Back Frame	6
		Side Panel	7
7	CONNECTIONS	Antenna Connection	8
		S-Video Connection	8
		AV Connection	8
		Y Pb Pr Connection	9
		HDMI Connection	9
		VGA Connection	10
		Headphone Connection	10
Power Cord Connection	10		
8	WALL MOUNT INSTALLATION		11
9	INITIAL SETUP	Putting The Unit On A Proper Place	12
		Source Selection	12
		Turning The Unit On For The First Time	12
10	TV SETUP	Picture Menu	14
		Audio Menu	16
		Time Menu	18
		Setup Menu	19
		Parental Menu	22
		TV Menu	25
Zoom Function	26		

CONTENTS

11	DISC FORMATS		27
12	CD / DVD OPERATION	Basic Operations	28
		Special Functions	31
		Mp3 / JPEG Playback	33
13	CUSTOMIZING THE DVD FUNCTION SETTINGS	DVD Function General Setup	34
		System Setup	34
		Language Setup	36
		Audio Setup	38
		Digital Setup	39
14	DISPLAY MODE	PC Formats	40
		Video Formats	41
15	SPECIFICATION		42
16	TROUBLE-SHOOTING GUIDE	DVD Symptom	43
		TV Symptom	44

SAFETY CLASS :This is an IEC safety class I product and it must be grounded for safety.

SAFETY PRECAUTION

* CAUTION MARKING WAS LOCATED AT BOTTOM ENCLOSURE OF THE APPARATUS. **PLACEMENT INFORMATION**



WARNING : TO REDUCE THE RISK OF ELECTRIC SHOCK, DO NOT REMOVE COVER (OR BACK). NO USER SERVICEABLE PARTS INSIDE. REFER SERVICING TO QUALIFIED SERVICE PERSONNEL.

 The lightning flash with arrowhead symbol, within an equilateral triangle, is intended to alert the user to the presence of uninsulated "dangerous voltage" within the product's enclosure that may be of sufficient magnitude to constitute a risk of electric shock to persons.

 The exclamation point within an equilateral triangle is intended to alert the user to the presence of important operating and maintenance (servicing) instructions in the literature accompanying the appliance.

CAUTION
INVISIBLE LASER RADIATION WHEN OPEN AND INTERLOCKS DEFEATED
AVOID EXPOSURE TO BEAM



 **CAUTION**

- DANGER OF EXPLOSION IF BATTERY IS INCORRECTLY REPLACED. REPLACE ONLY WITH THE SAME OR EQUIVALENT TYPE.
- USE OF CONTROLS OR ADJUSTMENTS OR PERFORMANCE OF PROCEDURES OTHER THAN THOSE SPECIFIED MAY RESULT IN HAZARDOUS RADIATION EXPOSURE.

 **WARNING:**

- TO REDUCE THE RISK OF FIRE OR ELECTRIC SHOCK, DO NOT EXPOSE THIS APPLIANCE TO RAIN OR MOISTURE.
- TO REVENT FIRE OR SHOCK HAZARD, DO NOT EXPOSE THIS UNIT TO RAIN OR MOISTURE. DO NOT PLACE OBJECTS FILLED WITH LIQUIDS ON OR NEAR THIS UNIT.
- SHOULD ANY TROUBLE OCCUR, DISCONNECT THE AC POWER CORD AND REFER SERVICING TO A QUALIFIED TECHNICIAN.

- Do not use this unit in places that are extremely hot, cold, dusty or humid.
- Do not restrict the airflow of this unit by placing it somewhere with poor airflow, by covering it with a cloth, by placing it on bedding or carpeting.

SAFETY INFORMATION

- When connecting or disconnecting the AC power cord, grip the plug and not the cord itself. Pulling the cord may damage it and create a hazard.
- When you are not going to use the unit for a long period of time, disconnect the AC power cord.

CONDENSATION INFORMATION

- When left in a heated room where it is warm and damp, water droplets or condensation may form inside the equipment. When there is condensation inside the unit, the unit may not function normally. Let the unit stand for 1-2 hours before turning the power on or gradually heat the room and let the unit dry before use.

RATING PLATE LOCATION

The rating plate is located on the rear of the unit.

FCC STATEMENTS

NOTE: This unit has been tested and found to comply with the limits for a Class B digital device, pursuant to Part 15 of the FCC Rules. These limits are designed to provide reasonable protection against harmful interference in a residential installation.

This unit generates, uses and can radiate radio frequency energy and, if not installed and used in accordance with the instructions, may cause harmful interference to radio communication. However, there is no guarantee that interference will not occur in a particular installation. If this unit does cause harmful interference to radio or television reception, which can be determined by turning the unit off and on, the user is encouraged to try to correct the interference by one or more of the following measures:

- Reorient or relocate the receiving antenna.
- Increase the separation between the unit and receiver.
- Connect the unit into an outlet on a circuit different from that to which the receiver is connected.
- Consult the dealer or an experienced radio/TV technician for help.

 **WARNING:**

Changes or modifications to this unit not expressly approved by the party responsible for compliance could void the user authority to operate the unit.

IMPORTANT SAFETY INSTRUCTIONS

- 1) Read these instructions.
- 2) Keep these instructions.
- 3) Heed all warnings.
- 4) Follow all instructions.
- 5) Do not use this apparatus near water.
- 6) Clean only with a dry cloth.
- 7) Do not block any ventilation openings.
Install in accordance with the manufacturer's instructions.
- 8) Do not install near any heat sources such as radiators, heat registers, stoves, or other apparatus (including amplifiers) that produce heat.
- 9) Do not defect the safety purpose of the polarized or grounding-type plug.
A polarized plug has two blades with one wider than the other.
A grounding type plug has two blades and a third grounding prong.
The wide blade or the third prong is provided for your safety.
If the provided plug does not fit into your wall outlet, consult an electrician for replacement of the obsolete outlet.
- 10) Protect the power cord from being walked on or pinched particularly at plugs, convenience receptacles, and the point where they exit from the apparatus.
- 11) Only use attachments / accessories specified by the manufacturer.
- 12) Use only with the cart, stand, tripod, bracket, or table specified by the manufacturer, or sold with the apparatus.
When a cart is used, use caution when moving the cart / apparatus combination to avoid injury from tip-over.
- 13) Unplug this apparatus during lightning Storms or when unused for long periods of time.
- 14) Refer all servicing to qualified service personnel. Servicing is required when the apparatus has been damaged in any way, such as the power cord or plug is damaged, liquid has been spilled or objects have fallen into the apparatus, the apparatus has been exposed to rain or moisture, does not operate normally, or has been dropped.
- 15) To prevent electric shock, ensure the grounding pin on the AC cord power plug is securely connected.



MAINTENANCE

CLEANING THE DISC

A defective or soiled disc inserted into the unit can cause sound to drop out during playback.

Handle the disc by holding its inner and outer edges.

- Do NOT touch the surface of the unlabeled side of the disc.
- Do NOT stick paper or tape on the surface.
- Do NOT expose the disc to direct sunlight or excessive heat.
- NEVER use solvents such as benzine or alcohol to clean the disc.
- Clean the disc before playback. Wipe the disc from the center outward with a cleaning cloth.
- Do NOT use irregular shaped discs (example : heart shaped, octagonal, etc.). They may cause malfunctions.

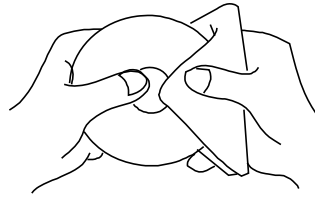

CLEANING THE UNIT

- Be sure to turn the unit off and disconnect the AC power cord before maintaining the unit.
- Wipe the unit with a dry soft cloth. If the surfaces are extremely dirty, wipe clean with a cloth that has been dipped in a weak soap-and-water solution and wrung out thoroughly. Wipe with a dry cloth.
- Never use alcohol, benzine, thinner, cleaning fluid or other chemicals. Do NOT use compressed air to remove dust.

IMPORTANT NOTE

Before transporting the unit, remove the disc from the disc compartment.

ACCESSORIES

Please check and identify the supplied accessories.

Remote control	x 1
Battery (AA)	x 2
Power Cord	x 1
Warranty Card	x 1
Instruction Manual	x 1

GETTING STARTED

USING THE REMOTE CONTROL

- Point the remote control at the remote sensor located on the unit.
- When there is a strong ambient light source, the performance of the infrared remote sensor may be degraded, causing unreliable operation.
- The recommended effective distance for remote operation is about 16 feet (5 meters).

TO INSTALL THE BATTERIES

1. Open the battery door.

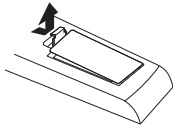

2. Insert 2 "AA" batteries

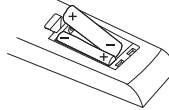

BATTERY REPLACEMENT

When the batteries become weak, the operating distance of the remote control is greatly reduced and you will need to replace the batteries.

CAUTION: Danger of explosion if battery is incorrectly replaced.

NOTES

- If the remote control is not going to be used for a long time, remove the batteries to avoid damage caused by battery leakage corrosion.
- Do not mix old and new batteries. Do not mix ALKALINE, standard (CARBON-ZINC) or rechargeable (NICKEL-CADMIUM) batteries.
- Always remove batteries as soon as they become weak.
- Weak batteries can leak and severely damage the remote control.

WARNING :

- Do not dispose batteries in a fire. Batteries may explode or leak.
- Batteries shall not be exposed to excessive heat such as sunshine, fire or the like.

CONTROL REFERENCE GUIDE

REMOTE CONTROL

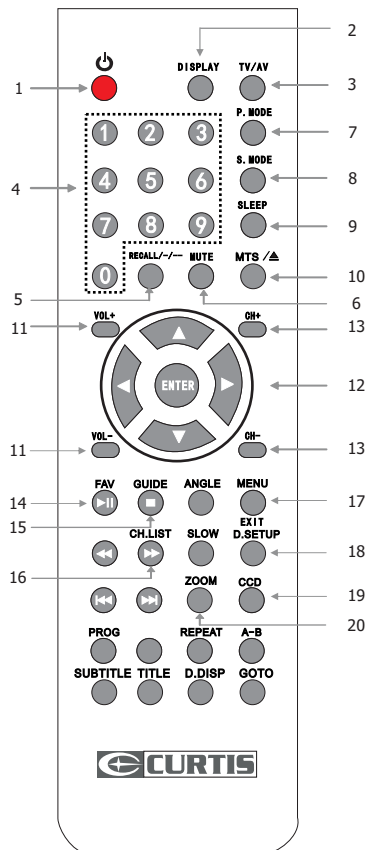

TV FUNCTION BUTTONS

- 1. STANDBY / ON Button**
Press to turn ON the unit or put it in STANDBY (OFF) mode.
- 2. Display Button**
Press to Display the source and channel information.
- 3. TV / AV Button**
Press to switch the source input.
- 4. Number (0 - 9) Buttons**
Press to select specific channels.
- 5. RECALL Button**
Press to switch repeatedly between the last two channels displayed.
- 6. MUTE Button**
Press to turn the sound on / off.
- 7. P. MODE Button**
Press to select from preset screen display settings to match the type of show you are watching.
- 8. S. MODE Button**
Press to select from preset sound settings to match the type of show you are watching.
- 9. SLEEP Button**
Press to set the SLEEP timer.
The unit will remain on for the time that is set, and will automatically shut off afterwards.
- 10. MTS (Multi Channel Television Sound) Button**
Press to select between MONO sound, STEREO sound and Secondary Audio Program (SAP).
- 11. VOLUME (+/-) Buttons**
Press to adjust the volume level.
- 12. CURSOR (▲▼◀▶) Buttons**
Press to highlight selections on a menu screen and adjust certain settings.
ENTER Button
Press to confirm selections on a menu screen.
- 13. CHANNEL (+/-) Buttons**
Press to change the TV channels.
- 14. FAVORITE Button**
Press to display a list of Favorite TV Channels you have added.
- 15. GUIDE Button (EPG)**
Press to view scheduled programming for the current channel viewed.
- 16. CHANNEL LIST Button**
Press to display a list of channels saved in the TV tuner memory. Use the ▲▼◀▶ buttons to highlight and make channel selection.
- 17. MENU Button**
Press to display the on-screen TV menu.
- 18. EXIT Button**
Press to exit the TV SETUP menu and return directly to normal viewing.
- 19. CCD Button**
Press to activate the Closed Captioning feature.
This function only works on programs broadcasted with captions.
- 20. ZOOM Button**
Press to set size of LCD display.

CONTROL REFERENCE GUIDE

REMOTE CONTROL

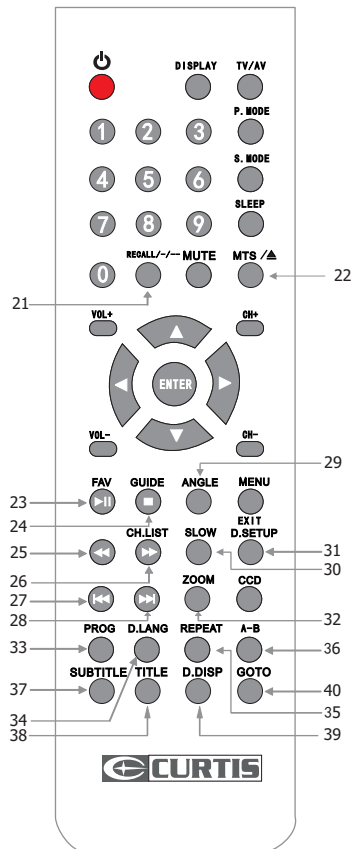

DVD FUNCTION BUTTONS

- 21. - / - Button**
Press to enter the title, chapter and track selection.
- 22. ▲ Button**
Press to eject a disc.
- 23. ► Button**
Press to start and resume playback of a disc.
- || Button**
Press to pause playback and single frame advance on DVDs
- 24. ■ Button**
Press to stop playing a disc. Press it twice, the unit's memory will be cleared.
- 25. ◀◀ Button**
Press to Fast reverse playback.
- 26. ▶▶ Button**
Press to Fast forward playback.
- 27. PREV ◀◀ Button**
Press to select the previous title, chapter or track on a disc.
- 28. NEXT ▶▶ Button**
Press to select the next title, chapter or track on a disc.
- 29. ANGLE Button**
Press to switch the camera angle of the video presentation when scenes with multiple camera angles are recorded on a DVD.
- 30. SLOW Button**
Press to perform slow forward playback of a DVD.
- 31. DVD SETUP Button**
Press to enter and exit the SETUP menu of the DVD.
- 32. ZOOM Button**
Press to zoom in or zoom out a image.
- 33. PROGRAM Button**
Press to enter into the favorite list to program the contents in a disc.
- 34. DVD LANGUAGE Button**
Press to select one of the sound languages programmed on a DVD.
- 35. REPEAT Button**
Press to repeat a chapter or title of a DVD.
Press to repeat a single track or whole CD.
- 36. A-B Button**
Press to perform point-to-point repeat playback on a DVD or CD.
- 37. SUBTITLE Button**
Press to select one of the subtitle languages programmed on a DVD.
- 38. TITLE Button**
Press to show title menu.
- 39. DVD DISPLAY Button**
Press to change disc status information displayed on the screen.
- 40. GOTO Button**
Press to skip directly to a specific location on a DVD/CD.

CONTROL REFERENCE GUIDE

FRONT VIEW

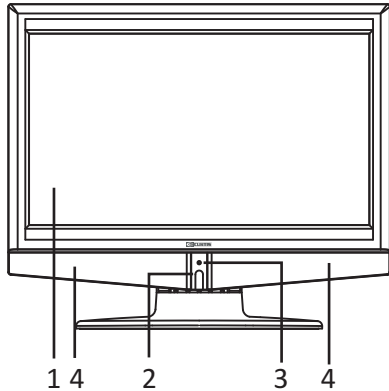

1. Color LCD Screen
2. Remote Sensor
Do not block this sensor or the remote control will not work.
3. Standby Indicator
Indicates whether the unit is ON or in STANDBY (OFF) mode.
Light in red: The unit is in STANDBY.
Light in green: The unit is turned ON.
4. Speakers

BACK VIEW

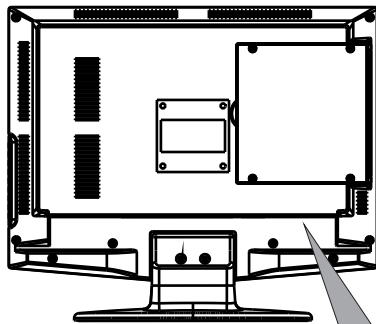

1. TV ANTENNA Terminal
2. HEADPHONE Jack
3. AUDIO IN Jack (Right)
4. AUDIO IN Jack (Left)
5. VIDEO IN Jack
6. S-VIDEO Jack
7. Y / PB / PR Jacks
8. PC AUDIO IN Jack
9. VGA IN Jack
10. HDMI IN Jack
11. AC IN (120V)
12. POWER SWITCH

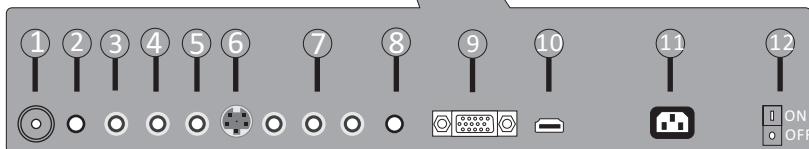

CONTROL REFERENCE GUIDE

SIDE VIEW

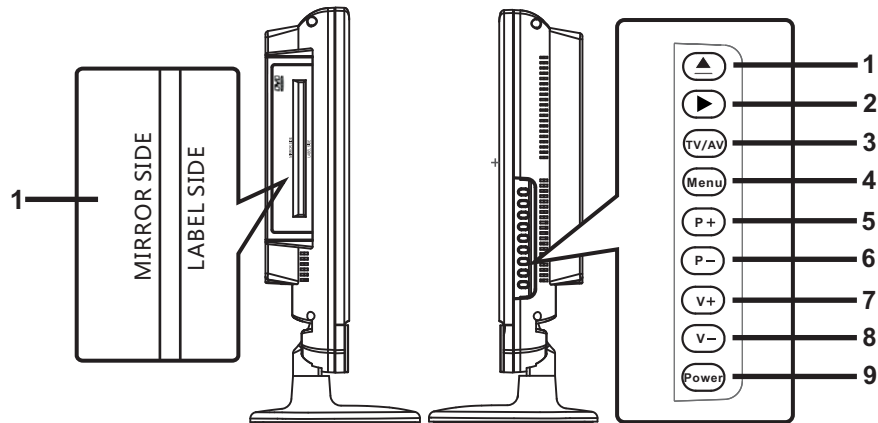

1. Disc Door
Insert discs to disc door

Note: When inserting a disc, please take note of the indication of direction around the disc door for operation. (right direction: put the label side of the disc against yourself)

1. ▲ Button
Press to eject a disc.
2. ► Button
Press to start or resume playback of a disc.
3. TV / AV Button
Select ATV, AV, S-VIDEO, YPbPr, HDMI, PC, or DVD.
4. Menu Button
Press to display the on-screen TV menu.
5. P + Button
Press to change the TV channels and up highlight selections on the menu screen.
6. P - Button
Press to change the TV channels and down highlight selections on the menu screen.
7. V + Button
Press to adjust the volume up.
8. V - Button
Press to adjust the volume down.
9. Power Button
Press to turn the unit on and off.

CONNECTIONS

CONNECTING A TV ANTENNA / CABLE / SATELLITE

To view television channels correctly, a signal must be received from one of the following sources:

- An indoor or outdoor aerial antenna
- A cable system
- A satellite system

NOTE

For receiving over-the-air TV broadcasts, we recommend that you use an external fixed antenna. Should you require the use of a temporary antenna, please ensure that you purchase an antenna with sufficient ability to receive in weak signal areas. Only when you are in close proximity to a transmitter will a temporary antenna reproduce a signal as strongly as a fixed antenna.

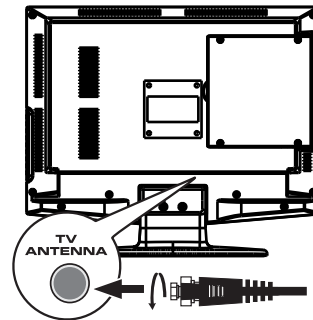

Satellite, cable or TV antenna cable to TV ANTENNA terminal (cable not included)

CONNECTING AN A/V DEVICE

To connect to other equipment such as a VCR, camcorder, satellite system or cable, etc.

Connecting to a VCR / Camcorder / Satellite System / Cable

Connect the AUDIO and S-VIDEO cable (not included) as shown.

Make sure you connect the cable from the other equipment (**AUDIO OUT** and **S-VIDEO OUT**) to this unit (**AUDIO IN** and **S-VIDEO IN**).

NOTE

Please refer to the user manual for the other equipment for more information.

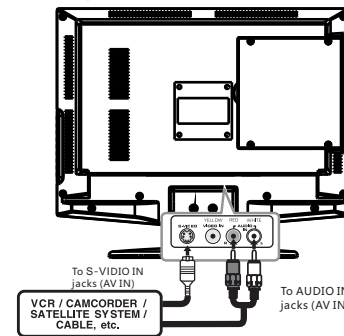

To S-VIDEO OUT / AUDIO OUT jacks

CONNECTING DEVICES WITH A COMPOSITE (YELLOW RCA-TYPE)

VIDEO OUTPUT

To connect A/V devices such as a VCR, video game system or camcorder.

Connecting to a VCR / Video Game System / Camcorder

Connect the AUDIO / VIDEO cable (not included) as shown.

Make sure you connect the cable from the other equipment (**AUDIO** and **VIDEO OUT**) to this unit (**AUDIO** and **VIDEO IN**).

NOTE

Please refer to the user manual for the other equipment for more information.

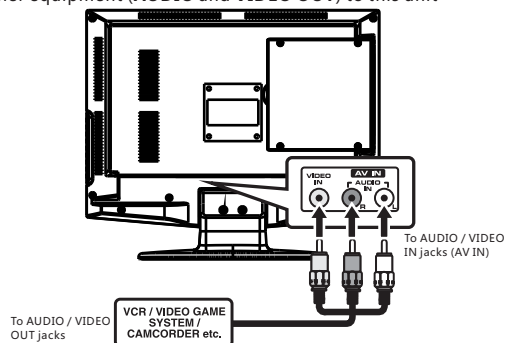

To AUDIO / VIDEO OUT jacks

To AUDIO / VIDEO IN jacks (AV IN)

CONNECTIONS

CONNECTING A HIGH-DEFINITION (HD) SOURCE USING COMPONENT CONNECTION

High-Definition (HD) Devices with component video output must be connected to the YPbPr input. Connect the component video cable and audio cable (not included) as shown. Make sure you connect the component video cable and audio cable from the other equipment (**COMPONENT OUT** and **AUDIO OUT**) to this unit (**COMPONENT IN** and **AUDIO IN**).

NOTE

When connecting a DVD player to the television, the picture resolution is solely dependent upon the resolution supported by the DVD player attached. DVD player resolutions vary from 480i to 1080i, and this television can support DVD players up to a maximum resolution of 1080i.

*** May require a subscription for receiving HD channels, check with your cable/satellite service provider for details.**

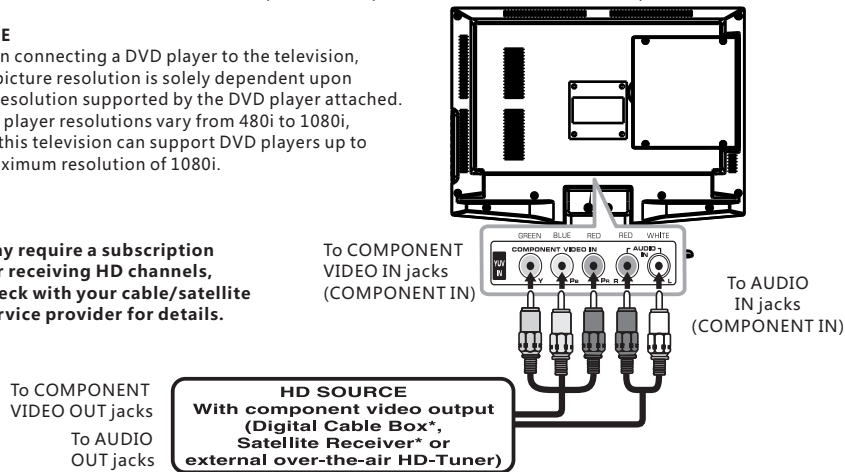

CONNECTING A HIGH-DEFINITION (HD) SOURCE USING HDMI CONNECTION

HDMI (High Definition Multimedia Interface) supports both video and audio on a single digital connection for use with DVD players, DTV, set-top boxes and other digital AV devices. HDMI was developed to provide the technologies of High Bandwidth Digital Content Protection (HDCP) as well as Digital Visual Interface (DVI) in one specification. HDCP is used to protect digital content transmitted and received by DVI-compliant or HDMI-compliant displays. HDMI has the capability to support standard, enhanced or high-definition video plus standard to multi-channel surround-sound audio. HDMI features include uncompressed digital video, a bandwidth of up to 2.2 gigabytes per second (with HDTV signals), one connector (instead of several cables and connectors), and communication between the AV source and AV devices such as DTVs.

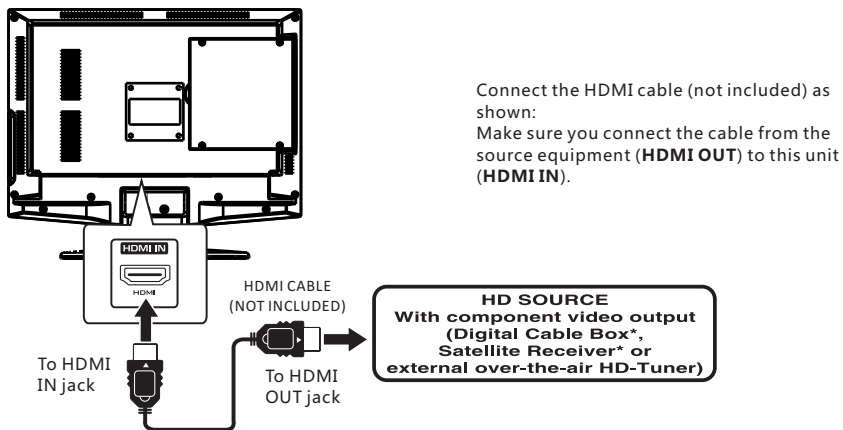

Connect the HDMI cable (not included) as shown: Make sure you connect the cable from the source equipment (**HDMI OUT**) to this unit (**HDMI IN**).

CONNECTIONS

CONNECTING A PC

Connect the 15-pin D-SUB PC/VGA connector from your computer to the 15-pin D-SUB PC/VGA input on this unit using a monitor cable and an audio cable (not included) as shown.

Make sure you connect the cable from the computer (VGA and AUDIO - PC OUT) to this unit (VGA and AUDIO - PC IN).

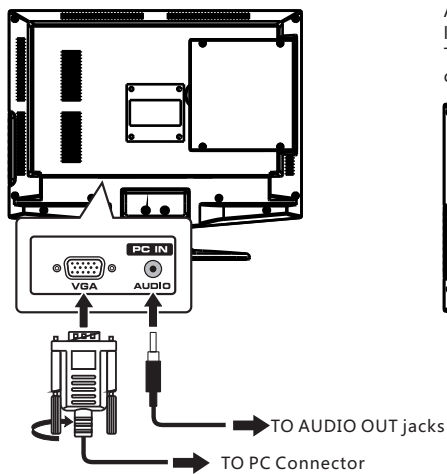

CONNECTING HEADPHONES

- Turn down the volume before connecting headphones to the unit, then adjust the volume to your desired level.
- When headphones are connected, no sound will come from the front speakers.

NOTE

Avoiding listening to sound at high levels for prolonged period of time. This may be harmful to you and may cause hearing loss.

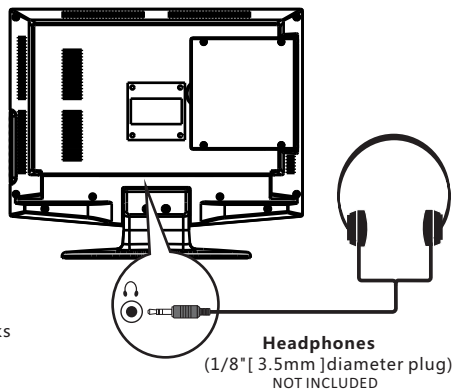

CONNECTING THE POWER CORD

You can power your TV unit by plugging the detachable AC power cord into the AC socket on the back of the unit and into a wall AC power outlet. Check that the rated voltage of your unit matches your local voltage. Make sure that the AC power cord is fully inserted into the unit.

NOTE

- Insert the power plug fully into the socket outlet. (If the power plug is loose, it could generate heat and cause fire.)
- Ensure that the power plug is easily accessible.
- Ensure the earth pin on the power plug is securely connected to prevent electrical shock.
- An apparatus with CLASS I construction shall be connected to a power socket outlet with a protective grounding connection.
- Do not touch the power plug with a wet hand. (This may cause electrical shock.)
- Do not use any power cord other than that provided with this TV. (This may cause fire or electrical shock.)
- Do not damage the power cord.
- Do not move the TV with the cord plugged in the socket outlet.
- Do not place a heavy object on the cord or place the cord near a high-temperature object.
- Do not twist the cord, bend it excessively, or stretch it.
- Do not pull on the cord. Hold onto the power plug body when disconnecting cord.
- Do not use a damaged power plug or socket outlet.

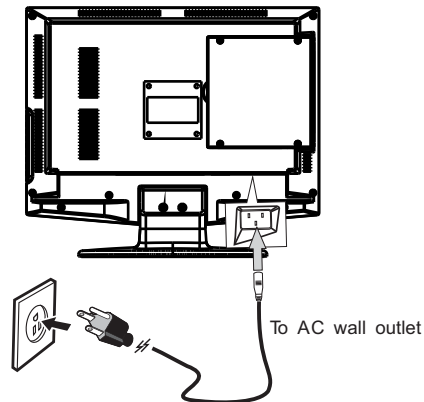

WALL MOUNT INSTALLATION

INSTALLING / REMOVING THE BASE STAND

WARNING: The LCD Display is very fragile, and must be protected at all times when removing the base stand.

Be sure that no hard or sharp object, or anything that could scratch or damage the LCD display, comes into contact with it. Do NOT exert pressure on the front of the unit at any time because the screen could crack.

1. Disconnect all cables or cords connected to the unit.
2. Lay the unit down on a flat surface with the back side facing up. Please make sure to place a soft cushioned material (such as a pillow or thick piece of foam) beneath the screen.
3. To remove the base stand, loosen screws off the holes then pull downwards to release the base stand.
4. To install the base stand, put the stand into the hole at the bottom of the TV then insert screws to the holes and tighten.

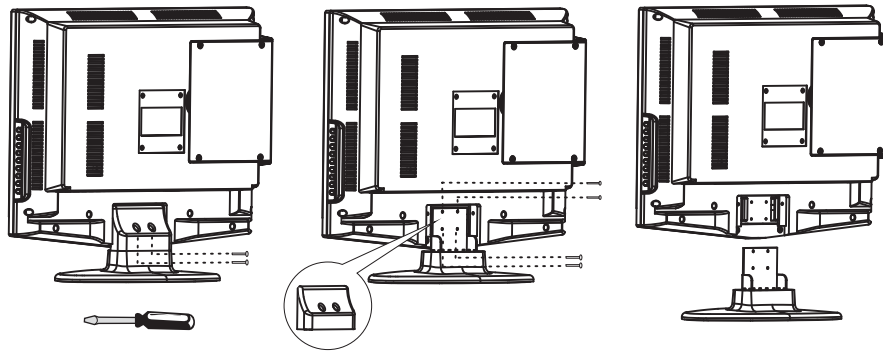

MOUNTING ON THE WALL

This unit is VESA-compliant, and is designed to be wall-mounted with a VESA-compliant 3" x 3" (75mm x 75mm) mounting kit designed for flat-panel TVs (not supplied). Mount this unit according to the instructions included in the mounting kit.

NOTE

Remove the base stand before mounting the unit on the wall.

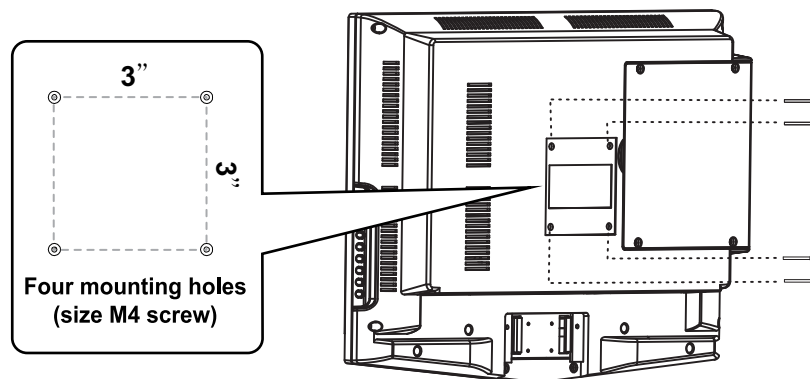

INITIAL SETUP

PUTTING THE UNIT ON A PROPER PLACE

When you turn on your television set for the first time, be sure to place it on a solid stable surface.

To avoid danger, do not expose the TV to water, or a heat source (e.g. lamp, candle, radiator).

Do not obstruct the ventilation grid at the rear and be sure to leave sufficient gaps around the unit.

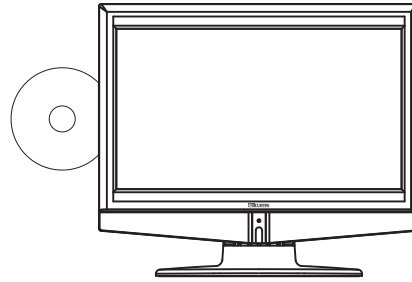

SOURCE SELECTION

1. Press the **TV /AV** button on the remote control.
2. Use the **▲** or **▼** button to select the options (TV, AV, S-Video, DVD, Component, HDMI, VGA) and select any of them using the **▶** button or the **ENTER** button.
(The screen will change to your desired source).

Note:
Before watching please make sure all necessary cables and devices are connected.

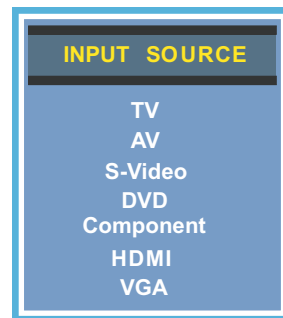

TURNING THE UNIT ON FOR THE FIRST TIME

After you have initially connected your TV antenna or cable (no set top box) turn the television ON.

A screen will display asking you to run a **Channel Auto Scan** to search and receive available local digital channels.

It is here where you will select antenna options and run **Channel Auto Scan**.

Channels will be stored in the TV tuner.

- Press the **MENU** button on the remote control.
- Using the **◀▶** buttons, scroll to highlight **TV** mode.
- Press the **▼** button to highlight **AIR/CABLE**.

Please run
Channel Auto Scan
in the TV menu

INITIAL SETUP

How to Navigate

Air Mode: Select **AIR** when connected to an indoor/outdoor antenna.

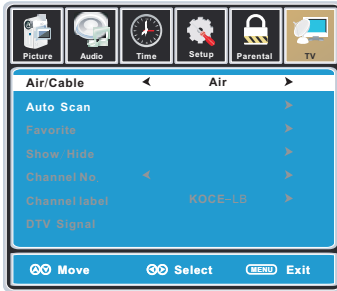

- Press the **▼** button to highlight **AIR**.

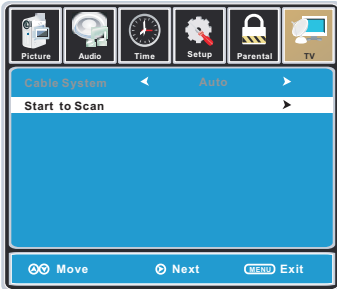

- Press the **▼** button to select **Auto Scan** then press the **▶** button to start Channel Auto Scan.



- Channel Auto Scan may take several minutes to complete.

Cable Mode: Select **CABLE** if you subscribe to a pay television service including satellite.

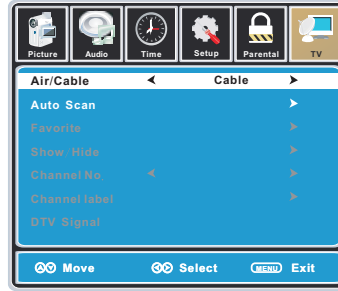

- Using the **◀▶** button to highlight **CABLE**.

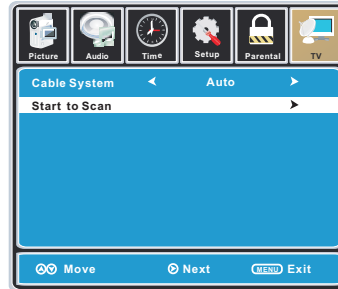

- Press the **▼** button to select **Auto Scan**. Press the **ENTER** button and the cursor will move up and CABLE SYSTEM will be displayed next.
- Press the **▶** button to select **STD > IRC > HRC > Auto** (Auto is recommended).
- Press the **▼** button to select **Auto Scan** and press **ENTER** to start Channel Auto Scan.



- Channel Auto Scan may take several minutes to complete.

NOTE: For cable or satellite users with no TV antenna, there no need to run Channel Auto Scan. Connect your cable or satellite set top box to one of the available inputs on the TV for viewing.

TV SETUP

PICTURE MENU

The **PICTURE** menu offers options to enhance and refine the picture displayed on your TV based on ambient room light and personal preferences. Adjustment options include contrast, brightness, color, sharpness and color temperature.

How to Navigate:

Press the **MENU** button on the remote control. Navigate using the ◀▶ buttons to select **PICTURE**.

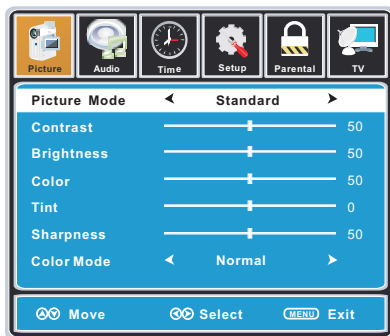

Press the ▼ button to highlight **Picture Mode**, then press the ▶ button to select your viewing preference from 4 factory options: STANDARD > DYNAMIC > MOIVE > PERSONAL.

The STANDARD setting is recommended for most viewing environments.

Depending on the ambient light level in the room, you may find one of the other options more pleasing.

To make more critical picture adjustments based on your own preferences in PERSONAL:

- Use the ▼ button to highlight **Contrast**. Navigate using the ◀▶ buttons to increase or decrease contrast intensity.



- Use the ▼ button to highlight **Brightness**. Navigate using the ◀▶ buttons to increase or decrease overall brightness.

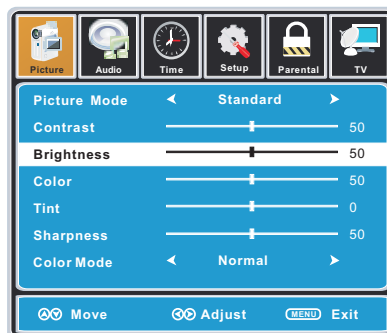

TV SETUP

PICTURE MENU

The **PICTURE** menu offers options to enhance and refine the picture displayed on your TV based on ambient room light and personal preferences. Adjustment options include contrast, brightness, color, sharpness and color temperature.

How to Navigate:

Press the **MENU** button on the remote control. Navigate using the ◀▶ buttons to select **PICTURE**.

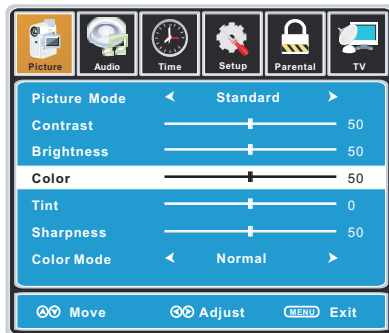

- Use the ▼ button to highlight **Color**. Navigate using the ◀▶ buttons to increase or decrease color intensity.

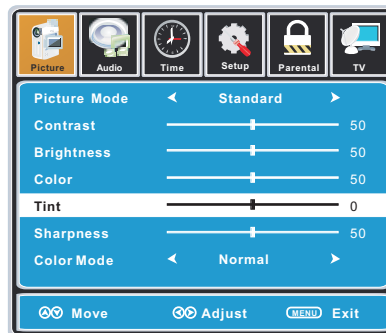

- Use the ▼ button to highlight **Tint**. Navigate using the ◀▶ buttons to adjust colors toward green or reddish tint.

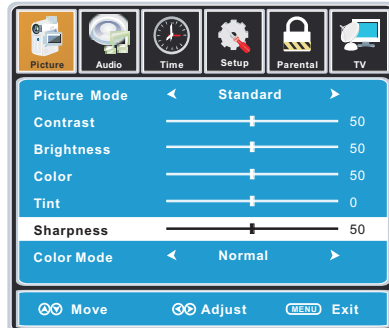

- Use the ▼ button to highlight **Sharpness**. Navigate using the ◀▶ buttons to soften or view crisper edges in the picture.



- Use the ▼ button to highlight **Color Temperature**. Navigate using the ◀▶ buttons to select COOL (more bluish tone), NORMAL or WARM. The default setting is NORMAL. WARM mode will provide color that is calibrated to D6500° Kelvin, the standard color that broadcast stations and the Motion Picture industry consider as the most accurate to view programming.

Note: When adjustments are completed, you may select another menu by pressing the **Menu** button.

TV SETUP

AUDIO MENU

The **AUDIO** menu offers options to make sound enhancements while listening through the built-in speakers and personal preferences.

Adjustment options include bass, treble, balance, surround, AVC and audio language.

How to Navigate:

Press the **MENU** button on the remote control. Navigate using the ◀▶ buttons to select **AUDIO**.

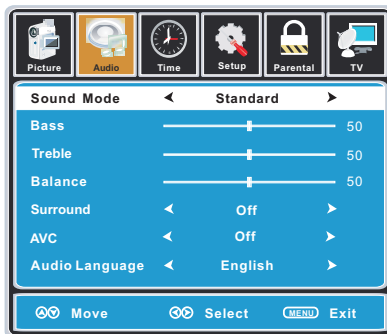

Press the ▼ button to highlight **Sound Mode**, then press the ▶ button to select your sound preference from 4 factory options: STANDARD > MUSIC > MOVIE > PERSONAL.

The STANDARD setting is recommended for most sound environments.

Depending on the surroundings in the room, you may find one of the other options more pleasing.

To make more critical audio adjustments based on your own preferences in PERSONAL:

- Use the ▼ button to highlight **Bass**. Navigate using the ◀▶ buttons to increase or decrease low frequency intensity.

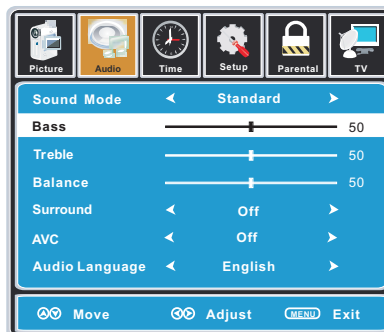

- Use the ▼ button to highlight **Treble**. Navigate using the ◀▶ buttons to increase or decrease high frequency intensity.

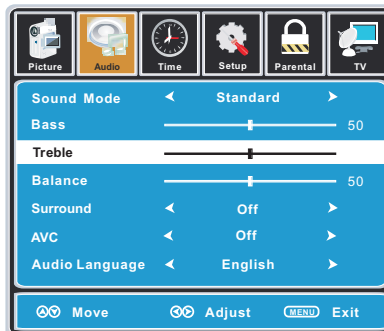

TV SETUP

AUDIO MENU

The **AUDIO** menu offers options to make sound enhancements while listening through the built-in speakers and personal preferences.

Adjustment options include bass, treble, balance, surround, AVC and audio language.

How to Navigate:

Press the **MENU** button on the remote control. Navigate using the ◀▶ buttons to select **AUDIO**.

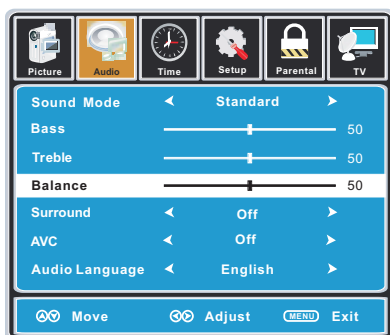

- Use the ▼ button to highlight **Balance**. Navigate using the ◀▶ buttons to adjust sound towards the right or left speaker.

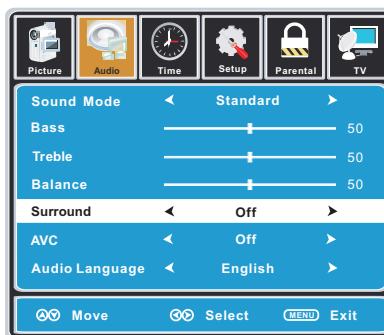

- Use the ▼ button to highlight **Surround**. Navigate using the ▶ button to turn the dimensional surround effect ON or OFF. (for built-in speakers only).

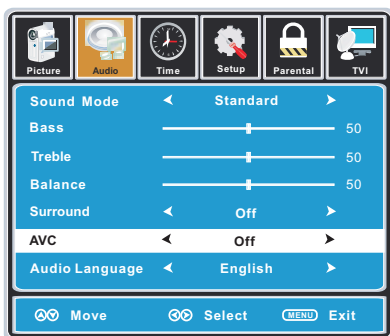

- Use the ▼ button to highlight **AVC**. Navigate using the ▶ button. In the ON position, Automatic Volume Control will limit the level of increased volume heard during television commercials and volume differences between inputs.



- Use the ▼ button to highlight **Audio Language**. Navigate using the ◀▶ buttons to select to listen to an alternative language broadcast (if available) English > Spanish > French.

(You may select an alternative language using the remote control by pressing **MTS**)

Note: When adjustments are completed, you may select another menu by pressing the **Menu** button.

TV SETUP

TIME MENU

The **TIME** menu includes adjustment of settings for your local time zone and daylight savings time. The clock will adjust automatically after the initial Channel Auto Scan of available broadcast channels in your area.

How to Navigate:

Press the **MENU** button on the remote control. Navigate using the ◀▶ buttons to select **TIME**.

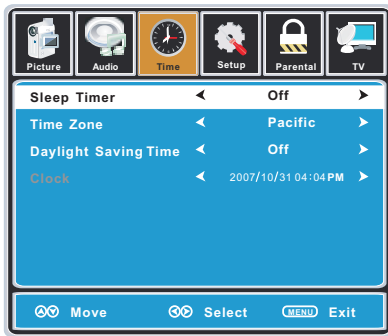

- Use the ▼ button to highlight **Sleep Timer**, then press the ▶ button to select among: 5min, 10min, 15min, 30min, 45min, 60min, 90min, 120min, 180min, 240min and off.



- Use the ▼ button to highlight **Time Zone**, then press the ▶ button to select among: EASTERN > CENTRAL > MOUNTAIN > PACIFIC > ALASKA > HAWAII.

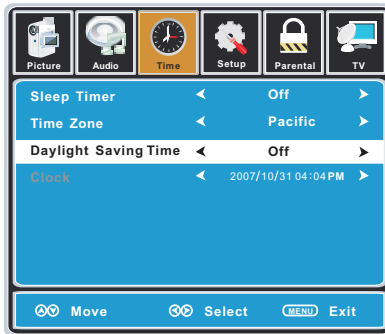

- Use the ▼ button to highlight **Daylight Saving Time**. Navigate using the ◀▶ buttons to turn this feature on or off.

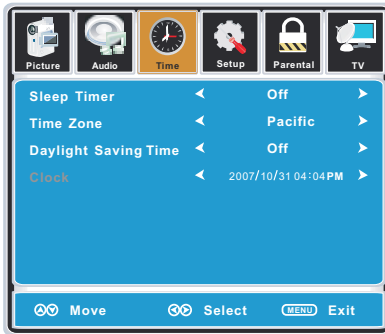

- **Clock:** Display the time at present.

Note: When adjustments are completed, you may select another menu by pressing the **Menu** button.

TV SETUP



SETUP MENU

In the **SETUP** menu you may change the initial set up of preferences that include settings for language, menu display, computer monitoring, closed captions, enhancement of black detail in the picture and resetting your TV back to its factory default status.

How to Navigate:

Press the **MENU** button on the remote control. Navigate using the ◀▶ buttons to select **SETUP**.

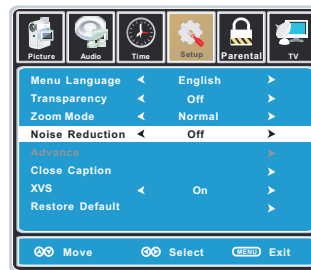
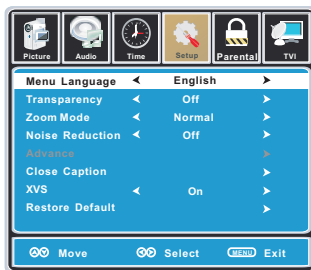

- Use the ▼ button to highlight **Menu Language**. Press the ▶ button to select the language you prefer among English, French and Spanish.
- Use the ▼ button to highlight **Noise Reduction**. Navigate using the ◀▶ buttons to reduce video noise: Off > Low > Medium > High (Default setting: medium)

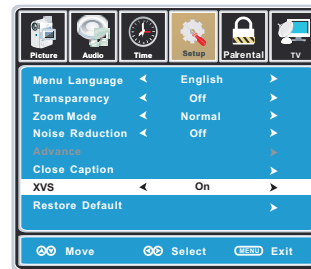
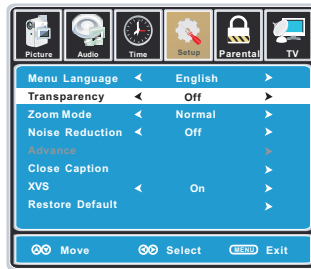

- Use the ▼ button to highlight **Transparency**. Navigate using the ◀▶ buttons to turn Off or On the translucent effect of the OSD.
- Use the ▼ button to highlight **XVS**. Navigate using the ◀▶ buttons to select: Off > On. XVS provides noticeable black detail enhancement that may be preferred.

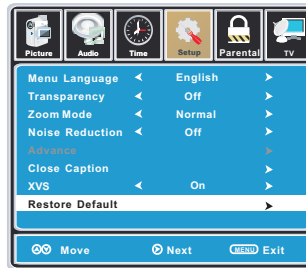
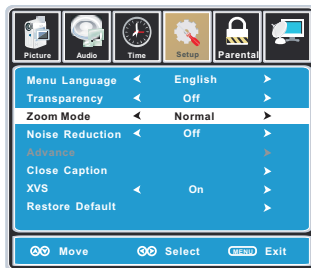

When prompted, Select "Yes" to confirm.

- Use the ▼ button to highlight **Zoom Mode**. Navigate using the ◀▶ buttons to select the viewing mode: Normal > Wide > Zoom > Cinema.
- Use the ▼ button to highlight **Restore Default**. Press the ▶ button to automatically set all adjustments back to their original settings.

TV SETUP



SETUP MENU

The **SETUP** menu includes adjustments for activating the **Closed Caption** feature for display on the television and customizing CC display types and font styles.

How to Navigate:

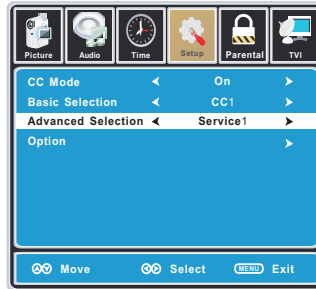
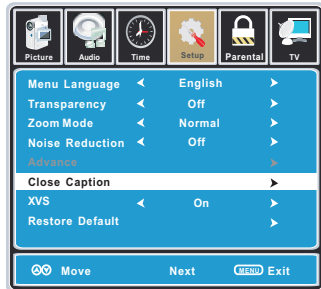

Press the **MENU** button on the remote control. • Use the **▼** button to highlight **Advance Selection**. Navigate using the **◀▶** buttons to select **SETUP**. Navigate using the **◀▶** buttons to select **Close Caption**. Press the **▼** button to highlight **Closed Caption** Service 1 - 6, then press the **▶** button to select from the following options.

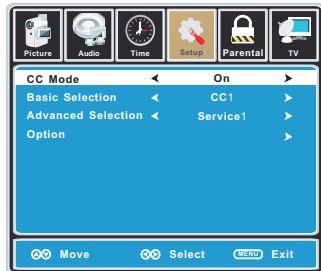

• Use the **▼** button to highlight **CC Mode**. Navigate using the **◀▶** buttons to select **Off > On > CC on Mute**.

• Use the **▼** button to highlight **Option**. Press the **▶** button to enter a menu with options to customize text fonts, colors and opacities.

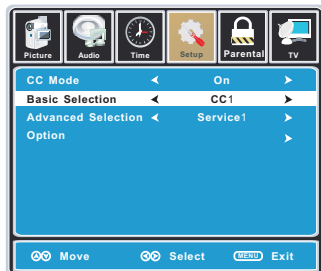

• Use the **▼** button to highlight **Basic Selection**. Navigate using the **◀▶** buttons to select **CC 1-4, Text 1-4**.

Note: When adjustments are completed, you may select another menu by pressing the **Menu** button.

TV SETUP



SETUP MENU

In the **SETUP** menu you may adjust the position of images displayed on screen once you connect an input signal from your PC. Recommended resolution is 1366 x 768.

If your PC system uses a standard signal mode, the screen will adjust automatically. Connect an optional 3.5mm audio cable for stereo sound.

How to Navigate:

After connecting to a **PC**, press the **INPUT** button and highlight **VGA**, then press the **ENTER** button.

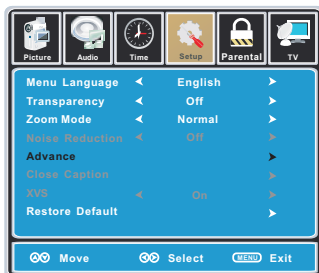

Press the **MENU** button on the remote control and navigate using the **◀▶** buttons to select **SETUP**. Press the **▼** button to highlight **Advanced**, then press the **▶** button to select from the following options.

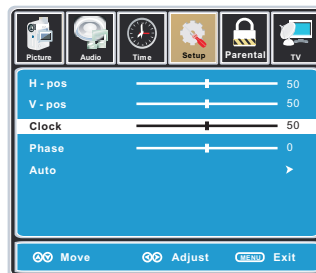

- Use the **▼** button to highlight **Clock**. Navigate using the **◀▶** buttons to control the width of the image.

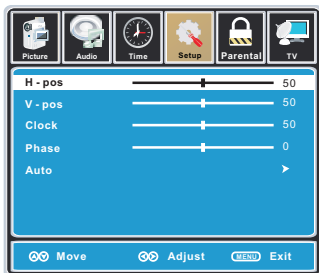

- Use the **▼** button to highlight **H-Pos**. Navigate using the **◀▶** buttons to adjust the position of images displayed from side to side.

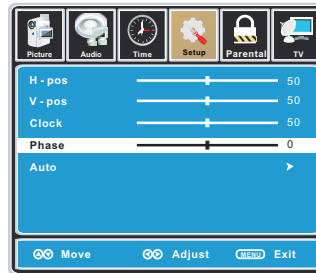

- Use the **▼** button to highlight **Phase**. Navigate using the **◀▶** buttons to improve focus and image stability.

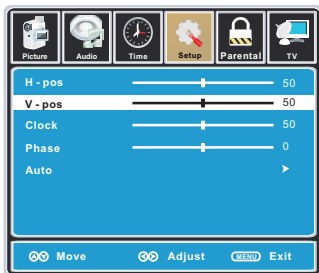

- Use the **▼** button to highlight **V-POS**. Navigate using the **◀▶** buttons to adjust the position of images displayed up and down.

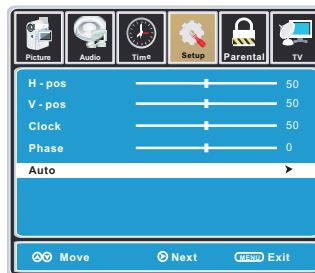

- Use the **▼** button to highlight **AUTO**. Press the **▶** button to automatically adjust the display to the best setting.



When prompted, Select "Yes" to confirm.

TV SETUP



PARENTAL MENU

In the **PARENTAL** menu you may block television by inputting passwords. To gain access and select your preferences within the **Parental** menu make certain your input is set to TV.

How to Navigate:

Press the **MENU** button on the remote control. Navigate using the ◀▶ buttons to select **Parental**.

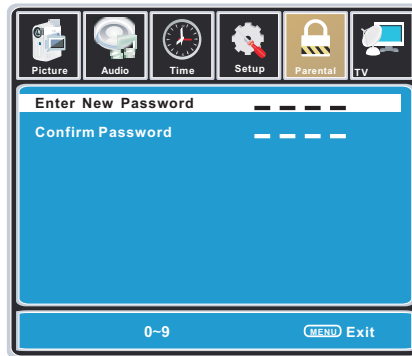

Press the ▼ button to highlight **ENTER PASSWORD**. Enter your 4 digit code (factory default code is "0000") unless previously changed.

• Use the numeric buttons to input a new 4 digit code by two times.

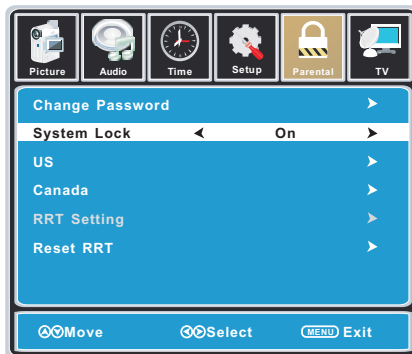

• To change the password, press the ▶ button to display a screen to enter your new password, then confirm again.

• To make changes to **PARENTAL** controls, highlight **SYSTEM LOCK** then press the ▶ button to ON.

NOTE: RRT Setting and Reset RRT are not user's adjustable settings.

TV SETUP

PARENTAL MENU

In the **PARENTAL** menu you may block television and movie programming based on U.S TV and movie rating guidelines. To gain access and select your preferences within the Parental menu make certain your input is set to TV.

How to Navigate:

Press the **MENU** button on the remote control. Navigate using the ◀▶ buttons to select **Parental**. Press the ▼ button to highlight **ENTER PASSWORD**. Enter your 4 digit code (factory default code is "0000") unless previously changed.

- To set parental controls for television programming or DVD movies, press the ▲▼ buttons to highlight **US**. Navigate using the ◀▶ buttons to highlight **TV/MPAA** menu.

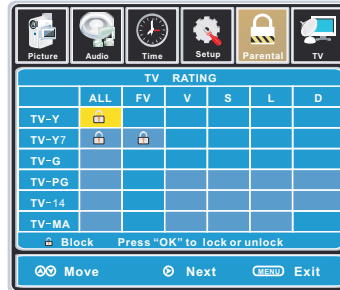
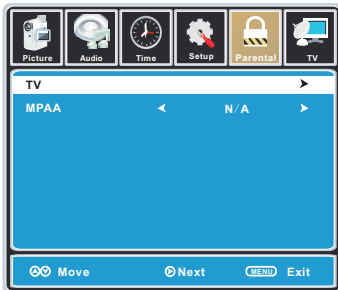

- Highlight **TV**, then press the ▶ button to enter the **TV Ratings** menu to select your preference.

Age	Defined as
TV-Y	Recommended for all children.
TV-Y7	Directed to older children.
TV-G	General Audience.
TV-PG	Parental Guidance Suggested.
TV-14	Parental Strongly Cautioned.
TV-MA	Mature Audience only.

Contents	Defined as
FV	Fantasy Violence
D	Suggestive Dialogue
L	Strong Language
S	Sexual Situations
V	Violence

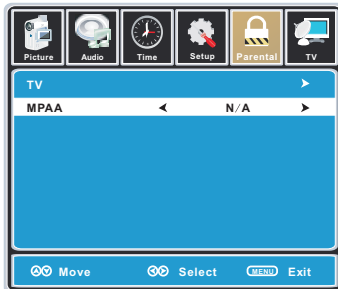

Rating	Defined as
N/A	Not rated.
G	GENERAL AUDIENCES, Suitable for all ages.
PG	PARENTAL GUIDANCE SUGGESTED - Some material may not be suitable for children.
PG-13	PARENTS STRONGLY CAUTIONED - Some material may be inappropriate for children under 13.
R	RESTRICTED, Under 17 requires accompanying parent or adult guardian for viewing in movie theaters.
NC-17	No one 17 or under admitted in movie theater.
X	Adult audience only.

- Highlight **MPAA** then press the ▶ button repeatedly to select your movie rating preference.

TV SETUP



PARENTAL MENU

In the **PARENTAL** menu you may block television and movie programming based on Canadian TV and movie rating guidelines. To gain access and select your preferences within the Parental menu make certain your input is set to TV.

How to Navigate:

Press the **MENU** button on the remote control. Navigate using the ◀▶ buttons to select **Parental**. Press the ▼ button to highlight **ENTER PASSWORD**. Enter your 4 digit code (factory default code is "0000") unless previously changed.

- To set parental controls for television programming or DVD movies, press the ▲▼ buttons to highlight **Canada**. Navigate using the ◀▶ buttons to highlight **Canada English/Canada French** menu.



Rating	Description
E	Exempt.
C	Children.
C8 +	Recommended for children age 8 and older.
G	GENERAL AUDIENCES, Suitable for all ages
PG	PARENTAL GUIDANCE SUGGESTED - Some material may not be suitable for children.
14 +	Viewers 14 years and older
18 +	Adult Programming.

- Navigate using the ▼ button to highlight **CANADA ENGLISH** then press the ▶ button repeatedly to select your ratings preference.



Rating	Description
E	Exempt.
G	GENERAL AUDIENCES, Suitable for all ages.
8 ans+	Not recommended for young children.
13 ans+	Not suitable for children under the age of 13.
16 ans+	Not suitable for children under the age of 16.
18 ans+	Adult Programming.

- Navigate using the ▼ button to highlight **CANADA FRENCH** then press the ▶ button repeatedly to select your ratings preference.

NOTE: When adjustments are completed, you may select another menu by pressing the **Menu** button.

TV SETUP

TV MENU

The **TV** menu provides for the setup of your television to receive TV channels, store your favorites, add or skip channels and label them by their call letters.

How to Navigate:

Press the **MENU** button on the remote control. Navigate using the **◀▶** buttons to select **TV**. Press the **▼** button to highlight your preferences.

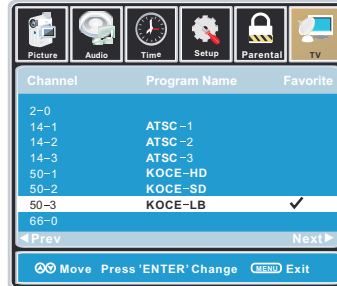
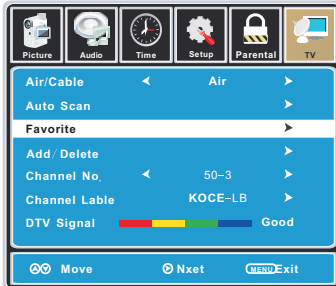

- Highlight **FAVORITE** to add channels to your Favorites List. Navigate using the **▲▼◀▶** buttons to select channels to be added or deleted from your list. Press the **ENTER** button to add or delete a channel. A checkmark indicates a channel has been added. You may also display your **FAVORITE** list from the remote control by pressing **FAV**.

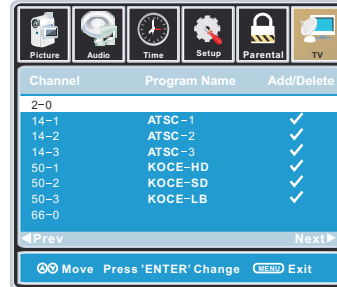
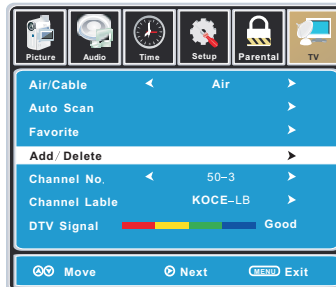

- Highlight **ADD/DELETE** to select or skip channels already in memory. Navigate using **▲▼◀▶** buttons to access the list of available channels. Press the **ENTER** button to change the channels status. A checkmark indicates a channel has been added.

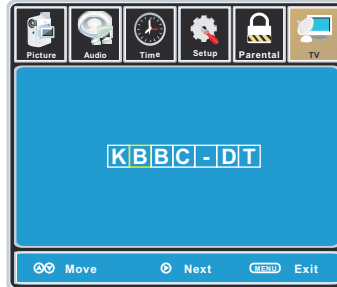
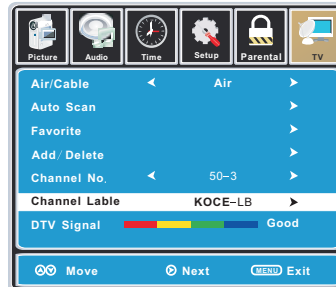

- Highlight **CHANNEL LABEL** to name or rename a broadcast channel. Navigate using the **▶** button to enter the screen menu to re-label a channel. Use the **▲▼** buttons to spell out each letter, number or character. Use the **◀▶** buttons to advance to the next space.

TV SETUP

ZOOM MODE

The **ZOOM** function offers several viewing display options on the 16:9 screen. Press **ZOOM** to cycle through the following widescreen settings.

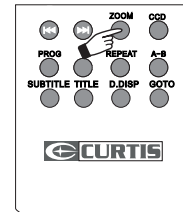

1. NORMAL

Recommended for viewing native widescreen content and undistorted 4:3 images. (With Black Bars)

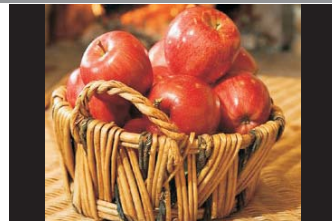

2. WIDE

Stretches certain 4:3 content and may reduce the black bars.



3. ZOOM

Stretches the image both vertically and horizontally to fill the screen when viewing widescreen content. The zoom effect will crop images somewhat.



4. CINEMA

When viewing 4:3 content, Cinema mode will fill the entire screen eliminating the side black bars. It may also eliminate or reduce black bars on certain widescreen movies.

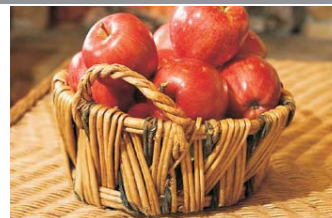

DISC FORMATS

NOTES ON COPYRIGHT

It is forbidden by law to copy, broadcast, show, broadcast on cable, play in public or rent copyrighted material without permission. Apparatus Claims of U.S. Patent Nos. 6,836,549; 6,381,747; 7,050,698; 6,516,132; and 5,583,936 licensed for limited viewing uses only. DVDs are copy protected, and any recordings made from these discs will be distorted. This product incorporates copyright protection technology that is protected by method claims of certain U.S. patents and other intellectual property rights owned by Macrovision Corporation and other rights owners. Use of this copyright protection technology must be authorized by Macrovision Corporation, and is intended for home and other limited viewing uses only, unless otherwise authorized by Macrovision Corporation. Reverse engineering or disassembly is prohibited.

The unit can play:

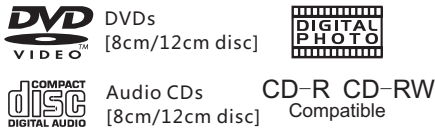

REGION MANAGEMENT INFORMATION

Region Management Information: This unit is designed and manufactured to respond to the Region Management Information that is encoded on DVDs. If the region number printed on the DVD does not correspond to the region number of this unit, this unit cannot play that disc.

The region number of this equipment is .

DISC FUNCTION OR OPERATION THAT IS NOT AVAILABLE

When the appears on the screen, it indicates that the function or operation attempted is not available at that time. This occurs because the DVD manufacturer determines the specific functions. Certain functions may not be available on some discs. Be sure to read the documentation provided with the DVD.

ICONS USED ON DVDS

Sample Icons

	1. English 2. French	Language selections for audio
	1. English 2. French	Language selections for subtitles
		Screen aspect ratio
		Multiple camera angles
		Region code indicator

NOTE

When playing back a CD-G (Graphics) or CD EXTRA disc, the audio portion will be played, but the graphic images may not be shown.

TITLES, CHAPTERS AND TRACKS

- DVDs are divided into "TITLES" and "CHAPTERS". If the disc has more than one movie on it, each movie would be a separate "TITLE". "CHAPTERS" are sections of titles.

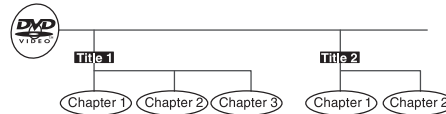

- Audio CDs are divided into "TRACKS". A "TRACK" is usually one song on an Audio CD.



NOTE

Numbers identify each title, chapter and track on a disc. Most discs have these numbers record on them, but some do not.

NOTES ON UNAUTHORIZED DISCS

You may not be able to playback some DVDs on this equipment if they were purchased from outside your geographic area or made for business purposes.

CD/DVD OPERATION

This owner's manual explains the basic instructions of this unit. Some DVDs are produced with limited operation during playback. For example, many DVDs do not allow users to skip government warnings, or in some cases previews or other features. This is not a defect in the unit. Refer to the instruction notes of discs.

"⊘" may appear on the screen during operation. A "⊘" means that the desired operation is not permitted by the unit or disc.

BASIC OPERATIONS

TURN ON AND OFF THE DVD FUNCTION

Turn on the LCD TV and then press the **TV / AV** button repeatedly to select DVD mode.

INSERT DISC TO DVD

Insert the Disc to the Disc door (label side of the disc has to face towards front of the unit), the player will load the disc automatically. There will have an on screen indication "**CLOSE**" then "**READ**". After loading the disc content, it will switch to play mode automatically. If the disc is already placed inside, the disc will be read automatically.

NOTE: For some discs, after loading the content of the disc, need to press the **▶▶** or select from the disc menu to start.

Please make sure when inserting the Disc, the label side of the disc should be facing you when inserting the Disc incorrectly, you may damage the DVD mechanism.

PLAYING A PICTURE FILE DISC

This unit can play JPG files recorded on CD-R and CD-RW discs.

1. Hold the disc by its edge and gently push it into the door, with the label side facing the front.
2. The unit will load the disc and automatically display the contents of the disc on the screen, while also beginning to play the picture file. These files will then be played back one by one.
3. Press the button **■** to go to the folder list.
4. Press the **▲** or **▼** button to highlight a file to play. Press the button **▶▶** to start playback.

PAUSING /PLAYING PLAYBACK

Press the button **▶▶** to switch between pausing and playing.

STOPPING PLAYBACK

Press the button **■** at the location where you want to interrupt playback. To resume playback at the position where the disc was stopped, press the button **▶▶**.

If you press the button **■** twice, the unit's memory will be cleared and pressing the button **▶▶** will reset the disc to the beginning.

SKIP (FORWARD / REVERSE)

- Press the **◀◀**PREV button to go back to previous chapters/tracks.
- Press the **▶▶**NEXT button to advance chapters/tracks.
- For an Audio CD, use the number buttons (remote control only) to jump directly to that track number.

TITLE (for DVD disc only)

- Press the **TITLE** button, there will have an on screen indication "TITLE" .
- Press the direction or numeric buttons to select your favorite title.

CD/DVD OPERATION

VOLUME

- Press the **VOL -** / **VOL +** buttons to adjust the output volume.
- NOTE:** Playback DVD discs in original code, is not adjustable.

MUTE

- Press the **MUTE** button to mute the audio output. There will have an on screen symbol indicate "MUTE".
- Press again to cancel, or Press the **VOL +** button to cancel and adjust the volume.
- In case there is no audio output, try to press the **MUTE** button to cancel mute.

ZOOM

- Press the **ZOOM** button to zoom in the picture.
- There are 6 zoom modes, press the **ZOOM** button to toggle between different zoom modes in sequent.
(Zoom2 - Zoom3 - Zoom4 - Zoom1/2 - Zoom1/3 - Zoom1/4 - Zoom OFF)
- In Zoom2-4, you may use the **▲, ▼, ◀, ▶** buttons to pan the picture for your favorite portion.

A - B

- In normal Playback, fast forward or fast reverse, press the **A-B** button at where you want to start the repeat portion. There will have an on screen indication "REPEAT A".
- In normal Playback, fast forward or fast reverse, press the **A-B** button again at where you want to stop the repeat portion. There will have an on screen indication "REPEAT A B".
- The repeat function started to playback the portion from A to B automatically.
- Press the **A-B** button again to cancel. There will have an on screen indication "A B CANCEL".

NOTE:

For Super VCD, VCD & CD discs, repeat A-B is only function within the same track. When playing the others, repeat A-B will cancel automatically.

For Super DVD discs, repeat A-B is only function within the same Title /Chapter. When playing the others, repeat A-B will cancel automatically.

PROGRAM

Using Program playback, you can select max. 16 tracks from the disc to playback in programmed order. OSD for program playback as below.

TITLE/CHAPTER PROGRAMMED PLAYBACK (DVD)

TITLE		CHAPTER	
T	C	T	C
1	5	9	13
2	6	10	14
3	7	11	15
4	8	12	16
PLAY		CLEAR	

TRACK PROGRAMMED PLAYBACK (CD)

TRACK			
1	5	9	13
2	6	10	14
3	7	11	15
4	8	12	16
PLAY		CLEAR	

- If it is in PBC ON status, using program playback will turn to PBC OFF automatically.
- According to the highlight area input the title and chapter number by the numeric buttons, press the **▶** button to start; or move to the **<PLAY>** by the navigation buttons, press the **ENTER** button to start.
- While playing the program, you may press the **PROGRAM** button to display the program menu for edit. To clear the program by moving to **<CLEAR>** by the navigation buttons, press the **ENTER** button. Or press the **■** button to end the program. When press the **▶** button again, the disc will play by sequent.
- While playing the program, there will have an on screen indication "PRG PLAY" and the current title and chapter number.

CD/DVD OPERATION

FAST FORWARD / FAST REVERSE

1. Press the ◀◀ or ▶▶ button when a disc is playing.

Each time the ◀◀ or ▶▶ button is pressed, the speed of fast scan changes in the following sequence:

FORWARD X 2 ---> FORWARD X 4 ---> FORWARD X 8 ---> FORWARD X 20 ---> PLAY

BACKWARD X 2 ---> BACKWARD X 4 ---> BACKWARD X 8 ---> BACKWARD X 20 ---> PLAY

2. Press the ⏸ button to play when you reach the desired point to resume playback at normal speed.

SLOW-MOTION PLAY (DVD)

1. Press the **SLOW** button on remote control in the play mode. Each time the **SLOW** button is pressed, the speed of slow-motion playback changes in the following sequence:

SF 1/2 ---> SF 1/3 ---> SF 1/4 ---> SF 1/5 ---> SF 1/6 ---> SF 1/7 ---> PLAY

2. Press the ⏸ button to return to the normal playback speed.

NOTE: During Slow motion, the sound will be off.

SUBTITLE SELECTION (DVD)

⏸ : [1 CHINESE]

1. While a DVD is playing, press the **SUBTITLE** button to display the current the language setting, as shown in the example.

2. Press the **SUBTITLE** button repeatedly to select the desired subtitle language.

NOTE

- If only one language is recorded, the language does not change.
- About two seconds later, playback continues with the new subtitle you selected.
- If no button is pressed within a few seconds, playback continues without changing the current subtitle.
- The number of languages recorded differs depending on the disc.
- This function can only be used for discs on which subtitles have been recorded in multiple languages.

LANGUAGE SELECTION (DVD)

⏸ : [1 ENGLISH DDD 2CH]

On some discs, the sound is recorded in two or more formats. Follow the directions below to select the preferred language and sound system.

1. While a disc is playing, press the **LANGUAGE** button to show the current audio format number.

2. Press the **LANGUAGE** button repeatedly to select the desired audio format.

Note

- If only one audio format is recorded, the number does not change.
- About two seconds later, playback continues in the new audio format.

ANGLE SELECTION (DVD)

Some DVDs contain scenes which have been shot from a number of different angles. For these discs, the same scene can be viewed from each of these different angles.

1. While you are playing a DVD with different angles recorded, press the **ANGLE** button to view the number of the current angle available.

2. Press the **ANGLE** button repeatedly to change the scene to the next angle in those recorded.

- About two seconds later, playback continues from the new angle you selected.
- If no button is pressed within 10 seconds, playback continues without changing the current angle.

⏸ : [2/3]

Sequence of angle shots
(Example)



NOTE

This function can only be used for discs on which scenes shot from multiple angles have been recorded.

CD/DVD OPERATION

SPECIAL FUNCTIONS

DISPLAY function (DVD)

Using **D.DISP**, you can check the current settings of the following items: ANGLE, AUDIO and SUBTITLE.

While the disc is playing, press the **D.DISPLAY** button repeatedly to display information on operation status.



LOCATING A SPECIFIC TITLE (DVD)

If a DVD contains title numbers, you can locate a specific title by directly selecting a title number.

1. Press the **GOTO** button.
2. Press the **◀** or **▶** button to highlight a specific field and press the corresponding number button(s) for the title you want.
3. Press the **ENTER** button to confirm. The Unit will start playback about 3 seconds later.



LOCATING A SPECIFIC CHAPTER / TRACK

If you know the chapter / track number you want to play, you can locate a specific chapter / track by directly selecting a chapter / track number.

1. Press the **GOTO** button to search for your desired chapter / track.
2. Press the **◀** or **▶** button to highlight a chapter / track and press the corresponding number button(s) for the chapter / track you want.
3. Press the **ENTER** button to confirm. Playback starts from the selected chapter / track.



LOCATING A SPECIFIC TIME

You can move to a specific location by entering its corresponding time (hours, minutes, seconds)

1. Press the **GOTO** button.
2. Press the **◀** or **▶** button to highlight time.
3. Press the corresponding number buttons for the setting point you want.
4. Press the **ENTER** button to confirm. The Unit will start playback about 3 seconds later.

NOTE

- Some discs may not respond to this process.
- Some scenes may not be located as precisely as specified.
- This method for accessing specific locations is available only within the current title of the DVD.



CD/DVD OPERATION

DVD REPEATING

You can play a specific title or chapter repeatedly. (Title repeat, chapter repeat, A-B repeat)

REPEATING A CHAPTER

You can play the same chapter repeatedly.

1. While the disc is playing, press the **REPEAT** button until the **REP: [CHAPTER]** indicator displays on the screen.

The current chapter is played repeatedly.

REPEATING A TITLE

You can play the same title repeatedly.

2. While the disc is playing, press the **REPEAT** button until the **REP: [TITLE]** indicator displays on the screen. The current title is played repeatedly.

TO RESUME NORMAL PLAYBACK

3. While the disc is playing, press the **REPEAT** button until the **REP: [OFF]** indicator displays on the screen.

CD REPEATING

You can play a single track and whole disc repeatedly.

REPEATING A SINGLE TRACK

You can play the same track repeatedly.

1. While the disc is playing, press the **REPEAT** button until the **REP: [REP 1]** indicator displays on the screen. The current track is played repeatedly.

REPEATING A WHOLE DISC

2. While the disc is playing, press the **REPEAT** button until the **REP: [REP ALL]** indicator displays on the screen. The whole disc is played repeatedly.

TO RESUME NORMAL PLAYBACK

3. Press the **REPEAT** button until the **REP: [OFF]** indicator displays on the screen.

REPEATING A SPECIFIC SECTION (DVD) (CD)

You can play a specific section repeatedly.

1. While the disc is playing, press the **A-B** button at the beginning of the section (**REPEAT A-** is displayed) you want to play repeatedly.
2. Press the **A-B** button again at the end of the section (**REPEAT A-B** is displayed).
3. The Unit will immediately begin replaying your selection.

TO RESUME NORMAL PLAYBACK

4. While the disc is playing, press the **A-B** button until the **A-B CANCEL** indicator displays on the screen.

NOTE

- A-B repeat can only be used within the same title. If the start and end of the section to be repeated are in different titles, A-B repeat is cancelled.
- The A-B repeat function does not operate in scenes where different camera angles are recorded.

CD/DVD OPERATION

MP3/JPEG PLAYBACK

After loading the MP3 / JPEG disc, it will start to scan for the stored MP3 / JPEG folders. Then will firstly display the MP3 contents automatically and start to play the first file (highlighted file). Screen as follow:

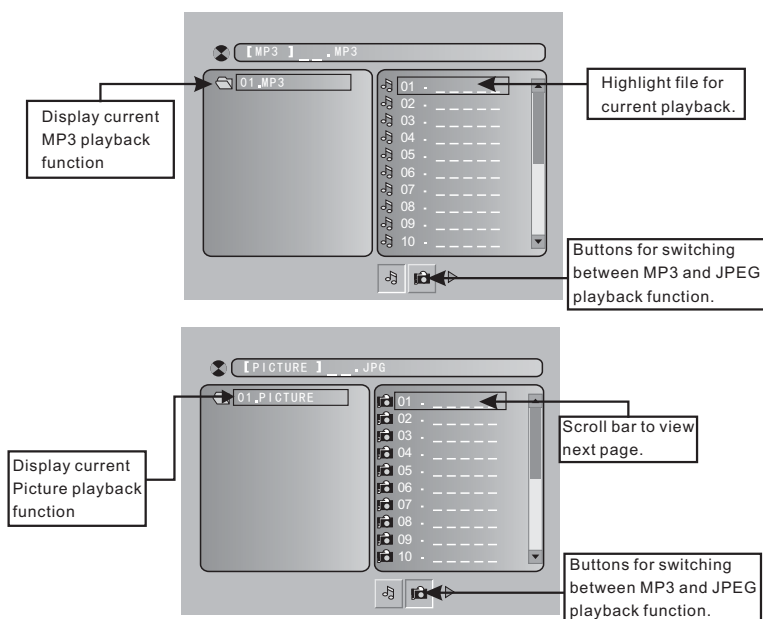

Using the navigation buttons to check you folder and playback or move to the file.

NOTE:

- Press the ◀, ▶ buttons to move the highlight to folders, documents or mode selection.
- Press the numeric buttons to select the contents directly. For number over 10, press the 0 button first. (e.g. File number 15, press 0 then 5.)
- When playback MP3 files, there is no picture display, only audio output.
- Playing the JPEG discs, press the **PROGRAM** button to select slide effects. There are 17 slide modes, press the **PROGRAM** button to toggle among different modes in sequence.
(Wipe top, Wipe bottom, Wipe left, Wipe right, Diagonal wipe left top, Diagonal wipe right top, Diagonal wipe left bottom, Diagonal wipe right bottom, Extend from center H, Extend from center V, Compress to center H, Compress to center V, Window H, Window V, Wipe from else to center Random, None)
- When play or pause with picture playback, you may use the navigation buttons to flip / rotate the picture.
- ▲ button to flip horizontally.
- ▼ button to flip vertically.
- ◀ button to rotate left 90°.
- ▶ button to rotate right 90°.

Press the ◀◀ / ▶▶ buttons to select next / previous page or press numeric buttons to view the corresponding pictures.

- The maximum JPEG image size that can be displayed is 1280 x 1024.

CUSTOMIZING THE DVD FUNCTION SETTINGS



DVD Function General setup

DVD SETUP MENU is only available in DVD mode. So before starting to set up please make sure the unit is switched to the DVD mode.

Press the **TV/AV** button and use **▲** or **▼** button to highlight the DVD option, then press the **Enter** button to enter into the **DVD** mode.

NOTE: In Setup mode, the following functions may be cancel or pause :

TITLE, SUBTITLE, DISPLAY, PLAY, PAUSE, STOP, SLOW , FF, FR, PREV, NEXT,
GOTO, ZOOM, ANGLE, LANGUAGE, PROGRAM, REPEAT, A-B.



SYSTEM SETUP

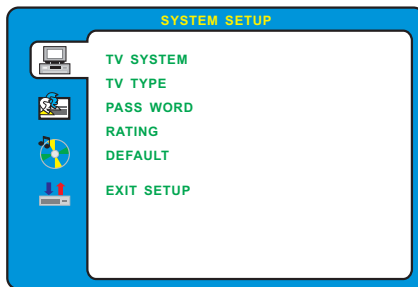

1. Press the **D.SETUP** button to activate the DVD player OSD menu.
2. Use the **▲** or **▼** button to select the **SYSTEM SETUP** menu, then press the **▶** button to enter the setting.
3. Use the **▲** or **▼** button to select the options (TV System, TV Type, Pass Word, Rating, Default, Exit Setup), then press the **▶** button to enter into for detailed options and adjust them using the **▲** or **▼** buttons.
4. Press the **◀** button to return to previous menu, repeat step 3 to adjust other settings.
5. Press the **D.SETUP** button to exit the OSD menu, or move the highlight to **EXIT SETUP** then press the **ENTER** button to exit.

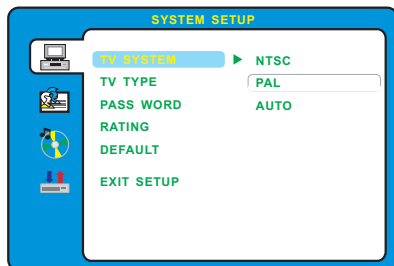

TV SYSTEM

Select the TV system available.

NOTE:

NTSC format is generally used for TVs. Check your TV user guide for supported formats. If PAL is selected with a non-compatible television you may experience interference or picture scrolling.

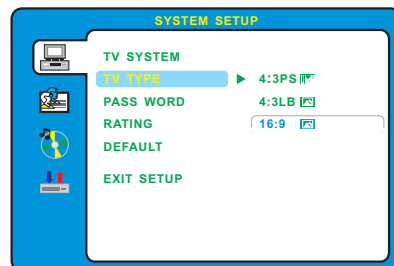

TV TYPE

DVDs are produced in a variety of screen aspect ratios. This menu enables you to select one of the three aspect ratios:

- 4:3 PS (Normal)
 - 4:3 LB (Normal)
 - 16:9 (Wide)
- Select the most appropriate aspect ratio for the DVD being viewed.

CUSTOMIZING THE DVD FUNCTION SETTINGS

4:3PS (Normal)

- When wide-screen video is played, this mode clips the right and left sides of the image so that it can be viewed on a conventional screen.
- Some wide-screen DVDs that do not permit Pan Scan mode playback are automatically played in letterbox mode (black bands top and bottom).



Cut off when a wide-screen video image is played.

Pan Scan

4:3LB (Normal)

- When wide-screen video is played in this mode on a conventional screen, black bands appear at the top and bottom of the screen.



Letter Box

16:9 (Wide Screen)

- This is the correct mode for playing wide-screen videos on a wide-screen.

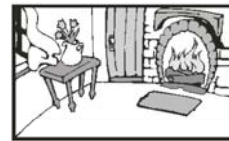

Wide-screen

NOTE:

- The displayable picture size is preset on the DVD. Therefore the playback picture of some DVDs may not conform to the picture size select.
- When you play DVDs recorded in the 4:3 aspect ratio, the playback picture will always appear in the 4:3 aspect ratio regardless of the TV TYPE setting.
- TV TYPE will always change to Wide screen after you switch off the unit.

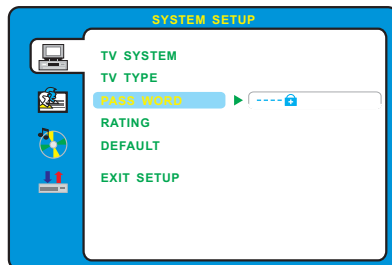

PASS WORD

The default setting is locked. No Rating selection or change password could be done.

To edit the Rating setting, please enter default password "0000" by the numeric buttons, then press the **ENTER** button to confirm.

To change password, input any 4 digit number when the lock is unlocked. Once the 4 digit number is entered, that will be your new password.

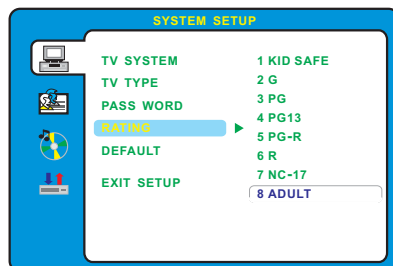

RATING

Playback for some discs with rating, you can select the rating setting according to your preference.

Rating restriction divided in eight different category from KID SAFE to ADULT.

NOTE:

Only editable when password is unlocked.

And only can function when password is locked.

It does not, however, reset either the Password or the Rating setting.

CUSTOMIZING THE DVD FUNCTION SETTINGS

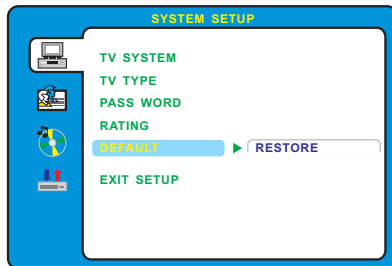

DEFAULT SETTING

Press the **ENTER** button to restore factory default. It takes 3-5 seconds to reset the DVD settings to the factory default.

LANGUAGE SETUP

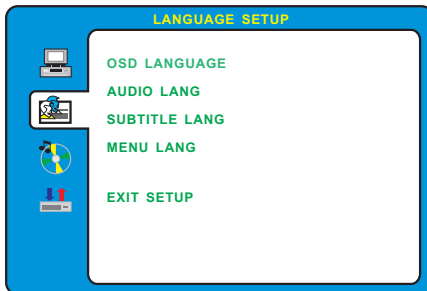

1. Press the **D.SETUP** button to activate the DVD player OSD menu.
2. Use the **▲** or **▼** button to select the **LANGUAGE SETUP** menu, then press the **▶** button to enter the setting.
3. Use the **▲** or **▼** button to select the options (OSD Language, Audio Lang, Subtitle Lang, Menu Lang, Exit Setup), then press the **▶** button to enter into for detailed options and adjust them using the **▲** or **▼** buttons.
4. Press the **◀** button to return to previous menu, repeat step 3 to adjust other settings.
5. Press the **D.SETUP** button to exit the OSD menu, or move the highlight to **EXIT SETUP** then press the **ENTER** button to exit.

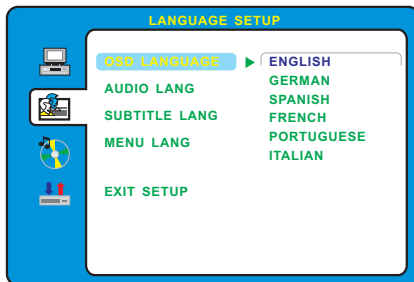

OSD LANGUAGE

Use the navigation buttons to select the **OSD LANGUAGE** setup icon, press the **ENTER** button to confirm. There are 6 languages for your selection, press the **▲** and **▼** buttons to switch among different languages (**ENGLISH/GERMAN/SPANISH/FRENCH/PORTUGUESE/ITALIAN**). Press the **ENTER** button to confirm.

NOTE:

If the selected language is not included in you DVD disc content, it will select the default language of the disc automatically.

CUSTOMIZING THE DVD FUNCTION SETTINGS

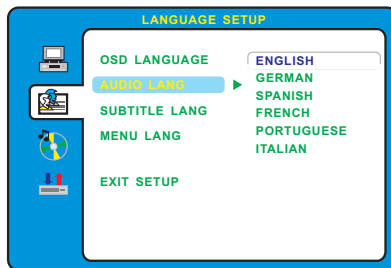

AUDIO LANGUAGE

Use the navigation buttons to select the **AUDIO LANG** setup icon, press the **ENTER** button to confirm. There are 6 languages for you selection, press the **▲** and **▼** buttons to switch among different languages. (**ENGLISH / GERMAN / SPANISH / FRENCH / PORTUGUESE / ITALIAN**).

Press the **ENTER** button to confirm.

NOTE:

If the selected language is not included in you DVD disc content, it will select the default language of the disc automatically.

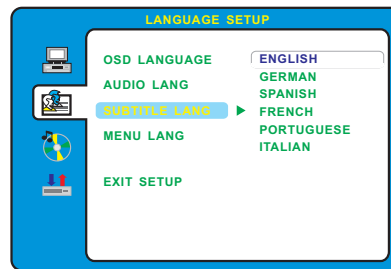

SUBTITLE LANGUAGE

Use the navigation buttons to select the **SUBTITLE LANG** setup icon, press the **ENTER** button to confirm. There are 6 languages for you selection, press the **▲** and **▼** buttons to switch among different languages. (**ENGLISH / GERMAN / SPANISH / FRENCH / PORTUGUESE / ITALIAN**).

Press the **ENTER** button to confirm.

NOTE:

If the selected language is not included in you DVD disc content, it will select the default language of the disc automatically.

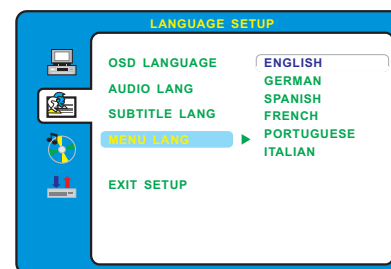

MENU LANGUAGE

Use the navigation buttons to select the **MENU LANG** setup icon, press the **ENTER** button to confirm. There are 6 languages for you selection, press the **▲** and **▼** buttons to switch among different languages. (**ENGLISH / GERMAN / SPANISH / FRENCH / PORTUGUESE / ITALIAN**).

Press the **ENTER** button to confirm.

CUSTOMIZING THE DVD FUNCTION SETTINGS

AUDIO SETUP

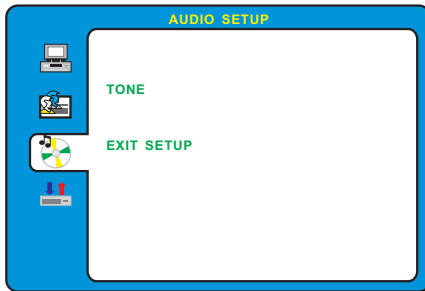

1. Press the **D.SETUP** button to activate the DVD player OSD menu.
2. Use the **▲** or **▼** button to select the **AUDIO SETUP** menu, then press the **▶** button to enter the setting.
3. Use the **▲** or **▼** button to select the options (Audio Out, Tone, Exit Setup), then press the **▶** button to enter into for detailed options and adjust them using the **▲** or **▼** buttons.
4. Press the **◀** button to return to previous menu, repeat step 3 to adjust other settings.
5. Press the **D.SETUP** button to exit the OSD menu, or move the highlight to **EXIT SETUP** then press the **ENTER** button to exit.

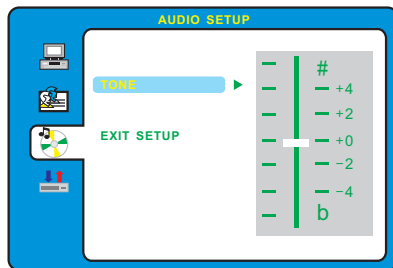

TONE

Use the **▲** and **▼** buttons to adjust the Tone setting.

CUSTOMIZING THE DVD FUNCTION SETTINGS

DIGITAL SETUP

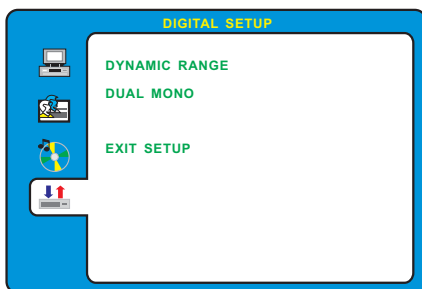

1. Press the **D.SETUP** button to activate the DVD player OSD menu.
2. Use the **▲** or **▼** button to select the **DIGITAL SETUP** menu, then press the **▶** button to enter the setting.
3. Use the **▲** or **▼** button to select the options (Dynamic Range, Dual Mono, Exit Setup), then press the **▶** button to enter into for detailed options and adjust them using the **▲** or **▼** buttons.
4. Press the **◀** button to return to previous menu, repeat step 3 to adjust other settings.
5. Press the **D.SETUP** button to exit the OSD menu, or move the highlight to **EXIT SETUP** then press the **ENTER** button to exit.

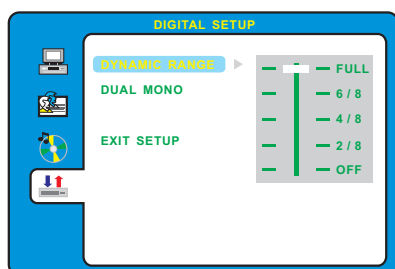

DYNAMIC RANGE

When switch the compress mode to "Audio output", adjust the compressed ratio for different effect.

When selected FULL, the peak signal value is smallest.

When selected OFF, the peak signal value is highest.

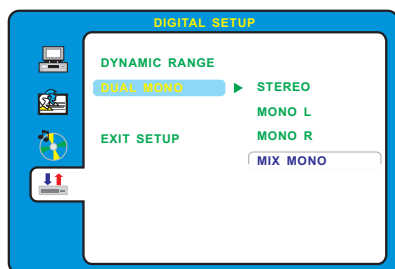

DUAL MONO

You can select four different audio output, **STEREO, MONO L, MONO R, MIX MONO**.

The audio out description of these selections is shown in the table below.

MODE	LEFT SPEAKER	RIGHT SPEAKER
STEREO	STEREO-L	STEREO-R
L-MONO	L-MONO	L-MONO
R-MONO	R-MONO	R-MONO
MIX-MONO	L-MONO+R-MONO	L-MONO+R-MONO

DISPLAY MODE

PC FORMATS

SUPPORTED PC INPUT MODE				
Resolution		Horizontal Scanning Frequency (KHz)	Vertical Scanning Frequency (Hz)	Format
640	480	31.5	60.0	DOS
640	480	37.9	72.0	VESA
640	480	37.5	75.0	VESA
800	600	35.1	56.2	VESA
800	600	37.9	60.0	VESA
800	600	48.1	72.0	VESA
800	600	46.9	75.0	VESA
1024	768	48.4	60.0	VESA
1024	768	56.5	70.11	VESA
1024	768	60.0	75.0	VESA
1366	768	47.7	60.0	VESA

NOTE:

- This product does not support the display mode not listed above.
In order to achieve the best display effect, please select the above-listed 11 display modes input signal.
- Because of the difference of display drivers output signal (especially non-standard signal output), the display image may appear little disturbance which can be adjusted through "AUTO" button on the PC menu.
- To prolong this unit's service life, please set your computer to power management mode.

DISPLAY MODE

VIDEO FORMATS

SUPPORTED COMPONENT / HDMI INPUT MODE				
Resolution		Horizontal Scanning Frequency (KHz)	Vertical Scanning Frequency (Hz)	Format
720	480	31.47	59.94	480 i
720	480	15.734	59.94	480 p
1280	720	37.5	50	720 p
1280	720	45	60	720 p
1920	1080	31.25	50	1080 i
1920	1080	33.75	60	1080 i

NOTE:

- The above listed formats are also related to the AV devices you are about to connect. Before you connect this unit with others please read all instructions carefully and make sure all necessary cables are connected.
- This unit may be incompatible with some other formats which are not meet the above conditions.

SPECIFICATION

Model Description		19" LCD TV / DVD COMBO
Panel	Panel Type	TFT LCD
	Diagonal Size	18.5 inches / 47 cm
	Screen Format	16:9
	Resolution	1366 768
	Brightness	300 nit
	Contrast	1000 : 1
	View Angle	170 (H) / 160 (V)
	Response Time	5 ms
Systems	Maximum Color	16.7 M
	Color System	ATSC/QAM/NTSC
	Sound System	M
	Audio System	BTSC
Input/ Output Jacks	Sound Output	L/R Speaker: 2W + 2W
	RF Input	75 ohm external terminal
	HDMI Input	Video: 480i, 480p, 720p, 1080i Audio: Two channel linear PCM 32, 44.1 and 48kHz, 16, 20 and 24 bits
	PC-RGB Input	D-sub 15pin G: 0.7Vp-p, 75ohms B: 0.7Vp-p, 75ohms R: 0.7Vp-p, 75ohms
	S-Video Input	Y: 1.0Vp-p, 75ohms C: 0.3Vp-p, 75ohms
	Composite Video Input	1.0 Vp-p, 75ohms RAC
	Component/Y Pb Pr Input	RAC Y: 1.0 Vp-p, 75ohms, 0.3V negative sync Pb: 0.7Vp-p, 75ohms Pr : 0.7Vp-p, 75ohms
	Sound Input	Phono jack 1: For CVBS/Component Audio input Phono jack 2: For PC-RGB Audio input 500mV rms, Impedance: 20k ohms
DVD	Headphone Output	3.5 mm diameter jack
	Region Code	1
	Disc Size	8cm / 12cm disc
Power	Compatible Disc Type	DVD, DVD-R/+R, DVD-RW/+RW, VCD, CD, CD-R, CD-RW
	Power Requirement	AC 120V, 60Hz
	Power Consumption	≤ 80W
Others	Standby Consumption	≤ 3W
	Dimension(with stand)	Approx. 460(L) 160(W) 394(H) mm
	Weight	4, 8 Kg
	Supplied Accessory	Power Cord, Instruction Manual, Remote Control, Warranty Card, Batteries

* This manual is only for your reference.
Specifications are subject to update without prior notice.

TROUBLESHOOTING GUIDE

SYMPTOM

CAUSE (AND REMEDY)

No power.

- Make sure the AC power cord is connected.
- Turn on the unit.

The remote does not function.

- Remove any obstacles between the remote and the unit.
- Use the remote near the unit.
- Point the remote at the remote sensor on the unit.
- Replace the batteries in the remote with new ones.

DVD

No sound or only a very low-level sound is heard.

- Make sure that you've selected DVD mode.
- The system is in pause mode. Press the ► button to return to normal play mode.
- Fast forward or fast reverse is performed. Press the ► button to return to normal play mode.
- Make sure the AUDIO / VIDEO output and AV IN input connections are correct.
- This unit is too hot. Power off the unit for 30 minutes to cool down.

No picture

- The region number of the disc doesn't match the region number of this unit.



The picture is not clear

- Clean the disc.
- The disc is scratched

Severe hum or noises heard.

- The plugs and jacks are dirty. Wipe them with a cloth slightly moistened with alcohol.
- Clean the disc

The disc does not play.

- There is no disc inside ("No Disc" appears on the screen).
- Insert the disc correctly with the label side facing yourself.
- Clean the disc.
- A non-NTSC disc has been inserted. The unit and disc region number are incompatible.
- Condensation may have formed inside the unit due to a sudden change in temperature. Wait about an hour for it to clean and try again.

TROUBLESHOOTING GUIDE

SYMPTOM	CAUSE (AND REMEDY)
TV	
Bad Picture (snow, multiple images distortion, blurry)	<ul style="list-style-type: none"> • Check the location of the antenna and adjust it if necessary. • Make sure the antenna cable is firmly connected. • Make sure all input cables are firmly connected.
No sound.	<ul style="list-style-type: none"> • Increase the volume. • Check whether the mute function has been activated on the Remote Control.
Black and White picture.	<ul style="list-style-type: none"> • Check the PICTURE setting within the PICTURE menu. • Check to make sure the program you are watching is broadcast in Color and not Black & White.
No picture or sound.	<ul style="list-style-type: none"> • Make sure the unit is plugged in and turned on. • Make sure that the ATV mode is selected. • Try a new channel to check for possible station trouble. • Make sure the antenna is connected properly. • Increase the volume. • Make sure the antenna or audio/video source device is working properly. • Make sure all cables are firmly connected. • Check for local interference.
Colored patches of picture.	<ul style="list-style-type: none"> • Make sure there are no unshielded electrical devices nearby that are causing interference. • Turn the TV off for 30 minutes, then try it again.
Panel function key does not respond correctly.	<ul style="list-style-type: none"> • Under the influence of electrostatic phenomenon, the product may malfunction and require user power reset. • Unplug and re-plug the AC power cord.
The display monitor's panel goes hot.	<ul style="list-style-type: none"> • LCD TV takes inside light phosphor. It may increase the temperature of the screen in some occasions. It's not a defect.
Unusual dots	<ul style="list-style-type: none"> • Black dots and Bright points may appear on the LCD screen. This is a structural property of the LCD panel and is not a defect.
Stripes on screen	<ul style="list-style-type: none"> • Adjust the impulse phase may decrease stripes. (RGB in)
The top of the monitor gets hot.	<ul style="list-style-type: none"> • It may occur during long-time working. It's not a defect.
Unable to select a certain channel.	<ul style="list-style-type: none"> • The channel may be skipped. Choose this channel by directly selecting the buttons from the remote control.
Disorder display at power on.	<ul style="list-style-type: none"> • This may be caused because of a very short interval between POWER OFF and ON. • Unplug the power and restart.